

Exploring the Design Space for Energy-Harvesting Situated Displays

Tobias Grosse-Puppenthal¹, Steve Hodges¹, Nicholas Chen¹, John Helmes¹,
Stuart Taylor¹, James Scott¹, Josh Fromm^{1,2}, David Sweeney¹

¹Microsoft Research, Cambridge, UK

{tgp, shodges, nchen, jhelmes, stuart, jws, dasween}@microsoft.com

¹Ubicomplab, University of Washington, Seattle, WA, USA

jwfromm@uw.edu

ABSTRACT

We explore the design space of energy-neutral situated displays, which give physical presence to digital information. We investigate three central dimensions: energy sources, display technologies, and wireless communications. Based on the power implications from our analysis, we present a thin, wireless, photovoltaic-powered display that is quick and easy to deploy and capable of indefinite operation in indoor lighting conditions. The display uses a low-resolution e-paper architecture, which is 35 times more energy-efficient than smaller-sized high-resolution displays. We present a detailed analysis on power consumption, photovoltaic energy harvesting performance, and a detailed comparison to other display-driving architectures. Depending on the ambient lighting, the display can trigger an update every 1–25 minutes and communicate to a PC or smartphone via Bluetooth Low-Energy.

Author Keywords

energy harvesting; e-paper; ubiquitous displays

ACM Classification Keywords

H.5.2. Information Interfaces and Presentation: User Interfaces - Graphical user interfaces; Input devices & strategies

INTRODUCTION

Information displays embedded within the environment take advantage of being situated within a particular context and location. These situated displays have proven to be useful in a variety of scenarios that include providing reminders [17], resource coordination [23], smart signage [26], and promoting awareness about user presence [28]. The literature on situated displays is clear that much of these devices' effectiveness derives from strategic placement and persistent visibility. Unfortunately, existing hardware designs present barriers to introducing continuously-operating displays into arbitrary locations in the environment.

Permission to make digital or hard copies of all or part of this work for personal or classroom use is granted without fee provided that copies are not made or distributed for profit or commercial advantage and that copies bear this notice and the full citation on the first page. Copyrights for components of this work owned by others than ACM must be honored. Abstracting with credit is permitted. To copy otherwise, or republish, to post on servers or to redistribute to lists, requires prior specific permission and/or a fee. Request permissions from Permissions@acm.org.

UIST '16, October 16–19, 2016, Tokyo, Japan

©2016 ACM. ISBN 978-1-4503-4189-9/16/10...\$15.00

DOI: <http://dx.doi.org/10.1145/2984511.2984513>



Figure 1. Our prototype ultra-low power displays (3 mm thick) combine an e-paper display with photovoltaic energy harvesting and Bluetooth LE wireless communications. The Post-it note form factor facilitates quick and versatile deployment. The photovoltaic panel is mounted on the rear of the unit (top) enabling the display to be deployed on a desktop (bottom left), attached to a monitor bezel (bottom right) or stuck to a window. We have built both segmented and dot-matrix style displays.

The power and connectivity requirements for continuously displaying live content necessitate the use of wired power, which limits where these devices can be practically deployed. This difficulty points to a need for wireless display devices that are “energy neutral”, i.e. harvest enough energy from the environment to operate indefinitely. Such displays would grant much more flexibility with regards to placement and reduce the effort required to maintain them.

In this paper we build on earlier related work by exploring the design space of energy-neutral wireless display devices. Based on our analysis, we identify a promising niche where photovoltaic cells are paired with low-power wireless protocols and bi-stable e-paper displays. We present two prototype displays that harvest energy from ambient light, and communicate using Bluetooth low energy (BLE). One particularly important dimension that we investigate using our prototypes is the trade off between power consumption and the number of pixels.

In an evaluation of our prototypes, we found that it was possible to do one update operation — comprising downloading new content and refreshing the display — every 1 minute under daylight or 25 minutes under indoor lighting. Our experiments also confirm the correlation between the number of pixels a display contains, update rate, and the power required to drive the display. We discuss strategies, such as using our displays as augmented-reality tags, to provide additional resolution and interactivity to our devices.

RELATED WORK

Energy Harvesting Displays

The use of light absorbing photovoltaic (PV) materials to harvest ambient light energy is increasingly explored in outdoor usage contexts such as digital signage [2] or for powering mobile devices [32, 35]. In indoor environments, PV-powered calculators [31], clocks and weather stations with reflective LCDs are well established [24]. However, more sophisticated applications are not common because the energy available in indoor environments is significantly lower than outdoors. Bi-stable displays [3] represent a lower power alternative to LCD-based displays, as they only require energy to change content, not to retain a static image. In 2004, E Ink created the first commercial application of such an e-paper display as an e-book reader [7]. Multiple products have been announced that combine e-paper with PV harvesting, but have never made it to the market, like the Toshiba Biblio Leaf e-reader [9]. In research, e-paper displays have been powered by PV cells to support the capturing of images [20], or powered by NFC as a mobile phone companion display [43, 4].

Situated Displays

Research into situated displays ranges from large displays for shared use to peripheral devices that show information in an ambient manner [22]. The exploration we present in this paper is primarily intended to support the latter class of applications. For many of these applications, information is consumed at a distance, suggesting that lower pixel counts would still be useful.

The central feature of the displays we explore in this paper are that they are energy-neutral, which frees these displays from the constraints that power normally imposes like deployment location or duration. For example, Elliot et al. identified power as a key hardware challenge that limits where situated displays can be deployed [8]. The amount of time Kuznetsov et al.'s were able to deploy their water consumption monitor was limited by battery life [18]. Furthermore, in applications of situated displays in the literature, like contextual reminders [17], visualizing resource consumption [13, 18], situated glyphs [14], and presence and room scheduling [23] the utility of the display is tightly bound to its location. Therefore, we believe technology enabling more flexible placement of these displays would be generally beneficial.

EXPLORING THE DESIGN SPACE

We now present a design space for ambient displays which are self-powered and network-connected. Specifically, we look at the available choices for the power source, the display technology, and the communications mechanism.

Energy harvesting

There have been many explorations into energy-neutral devices which scavenge power from the environment rather than being permanently plugged-in or occasionally re-charged. Paradiso and Starner [25] compared various harvesting sources in 2005, including ambient radio frequency, ambient light, ambient airflow, and a number of methods requiring physical contact such as heel strike during footsteps and thermoelectric energy from human body heat for a wristwatch.

One of the most promising sources identified is ambient light. PV cells are reportedly capable of achieving $100,000 \mu W/cm^2$ under bright sunlight and $100 \mu W/cm^2$ in illuminated office environments. Conversion losses reduce this in practice and end-to-end systems report figures of $20 \mu W/cm^2$ indoors [32], $7.4 \mu W/cm^2$ in unspecified conditions [19], $1,100 \mu W/cm^2$ outdoors, $1-10 \mu W/cm^2$ indoors [41] and $14 \mu W/cm^2$ indoors [20]. Our own prototypes, presented later, achieved $8 \mu W/cm^2$ on the inside of a window and $0.7 \mu W/cm^2$ on a desk.

In comparison, Paradiso and Starner's survey found that ambient radio frequency (RF) scavenging provided less than $1 \mu W/cm^2$ with respect to antenna area. Parks et al. harvest energy from television broadcasting and cellular cells [27]. Talla et al. [37] achieved $4 \mu W$ with a custom WiFi radio using a $10 cm^2$ antenna (i.e., around $0.4 \mu W/cm^2$) but used modified WiFi access points to maximize power transfer.

One recent work by Dementyev et al. [4] showed how an active-matrix e-paper display can leverage NFC both for power and data transmission, achieving a harvested power of $17.7 mW$ and a display update every $3.4 s$. However, in this case both the data and the power transmission rely on physical action by the user and is less suitable for our goal of ambient displays. There are also many energy sources that rely on movement or physical contact of some kind, including vibration and thermoelectric harvesting. We do not consider those further here as they are not suitable for remotely-updated ambient displays deployed in arbitrary environments.

Display Technology

A wide variety of display technologies exist, but here we ignore most of the emissive options due to the aggressive power consumption requirements of an energy-neutral system. However, an emissive technology worth mentioning are organic light-emitting diodes (OLEDs). Unlike backlit LCDs, the power consumption is directly proportional to the number and intensity of lit pixels. This has been used for low-power wireless ambient display on mobile devices, for example the Nokia/Microsoft 'glance' screen [1]. However, glance mode is estimated to consume 1-2% of the phone's battery [1]. With best-case assumptions that glance is always-on across the whole screen, and a battery lifetime of 16 hours, this indicates a best-case estimate of $55 - 110 \mu W/cm^2$.

Reflective liquid-crystal displays (LCDs), which contain no backlight, are significantly lower powered than emissive LCDs. Nevertheless, reflective LCDs still require continuous power to maintain a static image. Segmented LCDs employ a direct drive architecture to give the lowest power consump-

tion, for example $1.7 \mu A$ for a watch type LCD [34]. Dot-matrix memory LCDs employ a modified architecture with memory elements in the display backplane which obviates the need for an external display controller and reduces overall system power consumption. Sharp’s 2.7” memory display [42] has a power consumption of $2.4 \mu W/cm^2$. The majority of reflective LCDs are monochrome since color filters remove a large fraction of the light that would otherwise be reflected, which tends to result in poor contrast and washed-out images. However, Japan Display produce a full color memory-reflective LCD that consumes $93 \mu W/cm^2$ [12].

Bi-stable displays are perhaps the most relevant technology for achieving energy-neutral operation as they do not require any power to maintain a static image. One widespread technology is the electrophoretic display (EPD) [3] found in e-reader devices like the Amazon Kindle. Nehani et al. [20] developed new techniques to drive EPDs and lower power consumption per update from $25 mJ$ to $11 mJ$ for a 128x96 1.44” display. As with reflective LCDs, directly-driven segmented EPDs consume less power than matrix displays which typically require a dedicated display controller. However, because the controller is only active during display updates the difference is much lower. Other bi-stable display technologies include interferometric modulating (IMOD) displays like Qualcomm’s mirasol [30], which uses microelectromechanical structures, and cholesteric LCD (ChLCD), which uses specialized liquid crystals. Kent Display’s 320 x 240 ChLCD display consumes $271 mJ$ per update [16].

Communications

There are a number of different networking standards which can be considered for an energy-neutral ambient display. Dementyev et al. [5] surveyed a number of low-power radios in 2013. Over a period of 120 s during which a single transmission was made, Bluetooth LE (BLE) achieved the lowest average power consumption ($33 \mu W$) compared to ZigBee ($52 \mu W$) and ANT ($27 \mu W$). BLE is also more widespread, so a display relying on BLE may often be able to piggyback on existing BLE-enabled devices such as phones, tablets and laptops to provide network connectivity.

WiFi is similarly ubiquitous and supports higher bandwidth, however even low-power WiFi implementations require significant power to remain connected to a base station (e.g. $2600 \mu W$ [39]; $12,000 \mu W$ [10]). Recent work by Kellogg, Talla et al. [15] on passive WiFi has shown that by using backscatter techniques, a device can consume as low as $14.5 \mu W$ during active transmission and communicate with commodity WiFi base stations (compared to $35,000 \mu W$ for active communication for BLE). While very promising for the future, radios based on this technique are not yet commercialized or widely available. As already described, NFC (e.g. in [43, 4]) can provide enough bandwidth for display devices, but relies on physical contact and is not suitable for our aims.

PROTOTYPE IMPLEMENTATION

Based on the design space exploration for energy-harvesting situated displays in the previous section, we believe that an ambient-light-powered, electrophoretic display device using

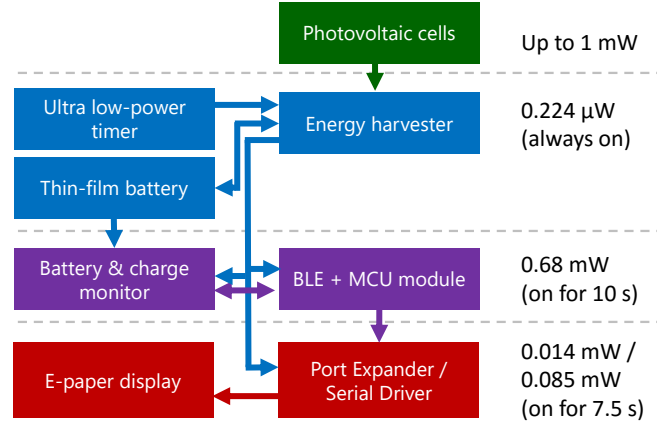

Figure 2. The display architecture comprises an energy harvester that charges a thin film lithium polymer battery. Power to all system components is gated based on an ultra low-power timer. Communication to a PC, tablet or smartphone is via a BLE which updates the display as necessary.

BLE for communications would be useful for the situated display applications described previously. Since such a device does not appear to have been previously reported in the literature, we prototyped it and characterized its performance.

System Architecture

A block diagram of our system architecture is depicted in Figure 2 and the actual hardware implementation is shown in Figure 3. We optimized all aspects of the system around low-power operation. For the energy harvesting source, we used a flexible thin-film amorphous silicon PV panel from Panasonic (AT-7665, 54 mm x 52 mm active area, 0.3 mm thick), which charges a $47 \mu F$ buffering capacitor. An energy harvesting IC (MAX17710) discharges this capacitor when it reaches a threshold voltage and feeds the energy into a battery. Each time this charging cycle occurs, $6.56 \mu J$ of energy is transferred into the battery. The efficiency of the energy harvesting circuit was measured to be around 50%, which compares favorably with the systems discussed in [33]. The efficiency is gradually reduced as the battery approaches full capacity to avoid overcharging. We used a tiny thin-film LiPo battery (ST EnFilm, 0.15 mm thick) which has a capacity of 0.7 mAh (less than 1% of a typical coin cell).

The fixed threshold voltage of our energy harvesting IC lies below the optimal power point for indoor lighting, and thus provides sub-optimal efficiency. An alternative IC like the BQ25570 [38] can provide more sophisticated power point tracking to match the current-voltage characteristic of a solar panel to increase efficiency. However, our current implementation requires fewer additional components.

Most of the time, only the energy harvester and a low-power timer (TPL5100) are supplied with power. This low-power part of the system consumes only $224 nW$. By comparison, with all components powered but in standby mode, current consumption would be at least $4.8 \mu W$, which would have a significant impact on the number of updates the display is able to perform in any given period. The timer,

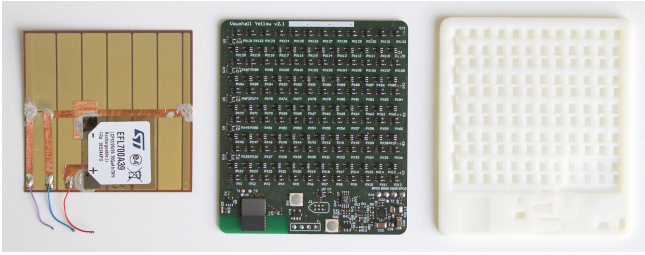

Figure 3. The hardware comprises a photovoltaic panel with a small thin-film battery from ST attached (left). A serial display architecture is constructed on a regular PCB using one memory element per pixel (middle). Both parts are joined together by a 3D-printed shim (right).

which triggers once every 60 seconds, causes an NRF51822 BLE+microcontroller IC (in an ISP130301 module) to wake up and monitor the battery voltage and the energy harvesting performance. If the battery voltage is sufficient, it then attempts to initiate communication over BLE to a host (which may be the user’s PC or smartphone). The BLE radio is left on for a period of 10 seconds to allow ample time for the host device’s BLE stack to wake and respond if it is in range. During this period, the host can send display updates to the display, and query the device’s battery or charging level status. After the 10 s period, power to the BLE+microcontroller module is switched off until the next timer trigger occurs.

In the implemented mode of operation, the display is only changed when a network connected host is available to provide the update. This approach was chosen in line with our aims for an ambient display, in order to maximize freshness of the information displayed. By avoiding use of energy on non-networked display changes, we maximize the frequency that enough energy is available to connect to the network.

Working with e-paper material

In our prototypes we use EPD film produced by OED Technologies [21]. As shown in Figure 4, these sheets consist of a transparent PET front layer coated with conductive indium-tin-oxide (ITO) laminated to the electrophoretic media containing charged ink particles. At the bottom of the stack is a heat-activated adhesive film that enables the sheet to be mounted to a circuit board. Conductive electrodes patterned on the gold-plated PCB define the segments/pixels of the final display. Figure 4 depicts this layer stack-up and Figure 5 shows the electrode patterns for our two prototype displays. Note the extra electrode towards the bottom of each PCB which is used to make contact with the ITO layer at the front of the EPD media. We use a commercial T-shirt press operating at 110 °C and apply pressure for 30 s to bond the e-paper film to the circuit board. A more detailed guide to producing custom displays with EPD film can be found in [36].

When a voltage is applied between any given PCB electrode layer and the ITO, the charged particles within the e-paper media move according to their polarity. The transition time from black to white (or white to black) depends on the voltage applied. The recommended voltage is typically ± 15 V [6] which gives an update time in the region of 120 ms. However, to save energy we use a 5 V supply which gives an update

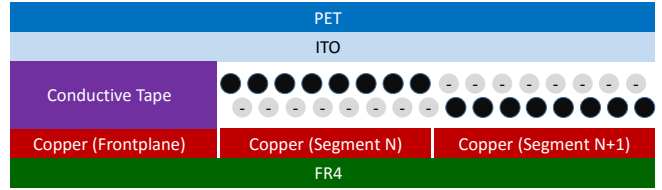

Figure 4. We define the contents of our display by copper segment on a circuit board. The e-paper media changes its appearance based on the polarity of the voltage between ITO and the segments.

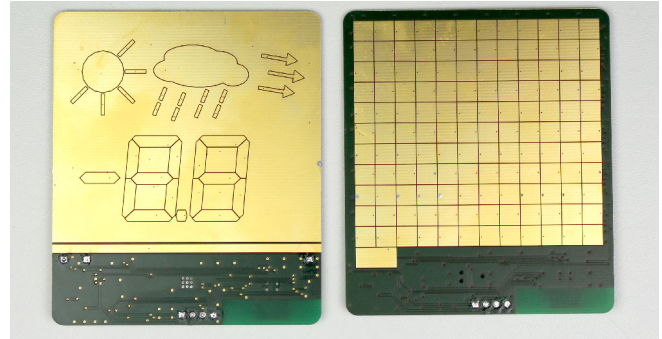

Figure 5. Our display pixels are defined on the circuit board as gold-plated electrode patterns which contact the rear of the e-paper media [6]. An additional electrode at the bottom of the display area (long strip for the segmented display at left and 2-pixel sized rectangle for the grid display at right) makes contact with the ITO front electrode. The e-paper is simply glued on top.

time of around 2.5 s. To give a crisp, ghost-free image we first set all pixels to black, then all to white, before finally rendering the desired image — this process takes 7.5 s in total.

Display driving architecture

We evaluated two alternative low-power display driver designs, shown in Figure 6: direct drive with connections to segmented pixels in a star topology, and a serial drive which mimics the memory-in-pixel architecture [12, 42]. To achieve the latter, we built a daisy-chain of discrete D-type flip flops, which requires just a clock and data line to write content to the display. In the future, we imagine these memory elements would be directly integrated into the display backplane. Unlike memory-in-pixel LCDs, our serial shift register does not need to be powered when the display is showing a static image, saving a significant amount of power.

Our direct drive architecture uses a TCA6424A port expander to drive up to 24 segments. The segmented display electrodes result in visually appealing and crisp images, while having the drawback that display content is pre-defined. Our serial architecture based on 74AHC1G79 D-type flip-flops is configured as an array of 12x11 pixels to offer more flexibility in what is displayed. Both of these approaches enable cheap and low-cost MCUs to control e-paper displays without the need for expensive, energy-consuming peripheral components.

ENERGY PROFILE

We now analyze the energy consumption of both of the display architectures, and also the energy harvested by the PV cells in various ambient lighting conditions.

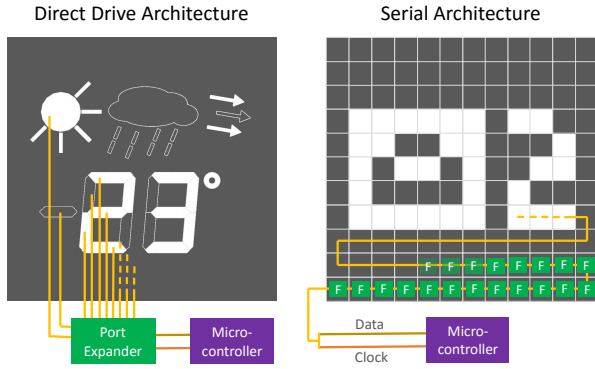

Figure 6. We designed two low-power display driving architectures: direct drive to 24 segmented pixels (left) and a serial architecture driving a grid of 12x11 pixels each of which has a discrete D-type flip flop (right).

	Pixels	Total energy (mJ)	Energy per pixel (mJ)	Energy per cm ² (mJ)
Prototype - Direct Drive Segments	24	0.11	0.00456	0.00086
Prototype - Serial Segments	132	0.64	0.00482	0.00032
Nehani et al. - Active Matrix	12288	10.70	0.00087	1.66047
Dementyev et al. - Active Matrix	46464	21.50	0.00046	0.98266

Table 1. Comparison of energy consumption for one full display update based on different display architectures. The energy figures for the active matrix display are taken from [4] and [20]. Both active matrix displays are significantly smaller than our segmented display prototypes.

Energy Consumption

As Figure 2 shows, for both display architectures, the MCU and BLE communications dominate the overall energy budget, using 0.68 mW during the 10 s period it is active, i.e. 6.8 mJ . In contrast, the display update takes a total of 0.1 mJ for the direct drive architecture, and 0.64 mJ for the serial architecture. So, a full network connection + display update cycle requires 6.9 mJ (direct drive) and 7.4 mJ (serial).

In order to analyze the design implications of our architectures, we compared them with a low-power implementation of an NFC-powered [4] and a PV-powered [20] active-matrix e-paper display. The active-matrix displays from Pervasive Displays [29] provide a much higher resolution with a pixel density of 128×96 [20] and 264×76 pixels [4], which enable a higher information density compared to our designs. However, in the applications we envisage for our displays, only small snippets of information need to be displayed, which typically does not require a high resolution. Also, a greater display size is favorable as interaction usually takes place at a distance. In our use-case it is more important to save as much energy as possible to achieve a higher number of updates.

The trade-off between energy consumption and number of pixels is depicted in Table 1. While the NFC-powered active matrix display is 44 % smaller than our serial display, an update requires 35 times more energy. Because of the low number of pixels, in our prototypes the power consumption is actually dominated by the e-paper frontplane itself rather than the driving electronics. In our serial architecture the energy consumption is 0.64 mJ , of which 0.48 mJ (75%) is due to the e-paper media (we measure $1.62\text{ }\mu\text{W}/\text{cm}^2$) and only 0.16 mJ due to the driving electronics. In our direct drive

architecture, the energy consumption is 0.1 mJ , of which 0.053 mJ (53%) is due to the e-paper media. Note that the active area of the this architecture is only 11% of the total area due to the segmented approach.

As the pixel density increases, the proportion of energy consumption due to the driving electronics grows, while the energy needed to update the e-paper media remains constant. This also helps to explain the much higher power consumption of the higher pixel count displays shown in Table 1. While it needs energy to maintain an image, a Sharp Memory LCD with equivalent size [11] requires less energy to drive a display update.

Although our serial architecture is very energy-efficient for a small number of pixels, the energy consumption rises quadratically with the number of pixels. When compared to an active matrix display with 46,464 pixels [4], our serial architecture would consume the same amount of energy when employing 4,690 segments in a single chain. However, the serial approach could be extended by breaking the chain into multiple sub-chains, effectively combining the direct drive and serial architectures. When combined with the networking requirements, if we had used the active matrix display from [4], the required duration between display updates would be 4 times higher, and the display would be much smaller.

Energy Harvesting

We now outline the number of update cycles that can be achieved in different deployments depending on the ambient light conditions. The harvested energy depends strongly on location and the ambient light. Our experiments were conducted in Cambridge, UK at the beginning of April 2016.

Figure 7 shows four typical deployment scenarios in an office environment using normal lighting, in which the office lights are motion-sensitive so they turn off automatically in the evening when nobody is present. We achieved the highest energy when attaching the displays to the inside of a window, and this allows a network connection and display update to be done every 33 s. In contrast, when placing the display on a desk updates can be done every 6 minutes, and when placed beside a PC screen we found updates every 25 minutes.

In terms of interaction experience, the user has to choose a location in which the amount of available light matches with the number of updates expected. The display is able to carry out approximately 100 updates on battery power alone, if the battery is fully charged. This allows operation during periods of low ambient light. Of course, the PV cells themselves could be used to determine when there is zero ambient light, and hence there is no point updating the e-paper display, which is not visible in the dark.

FUTURE WORK AND CONCLUSION

To date we have focused on use-cases where displays are updated based on remote synchronization data. However, in scenarios like content cycling or a simple timer countdown, it would be possible to store a series of images in the micro-controller's non-volatile memory and perform updates with-

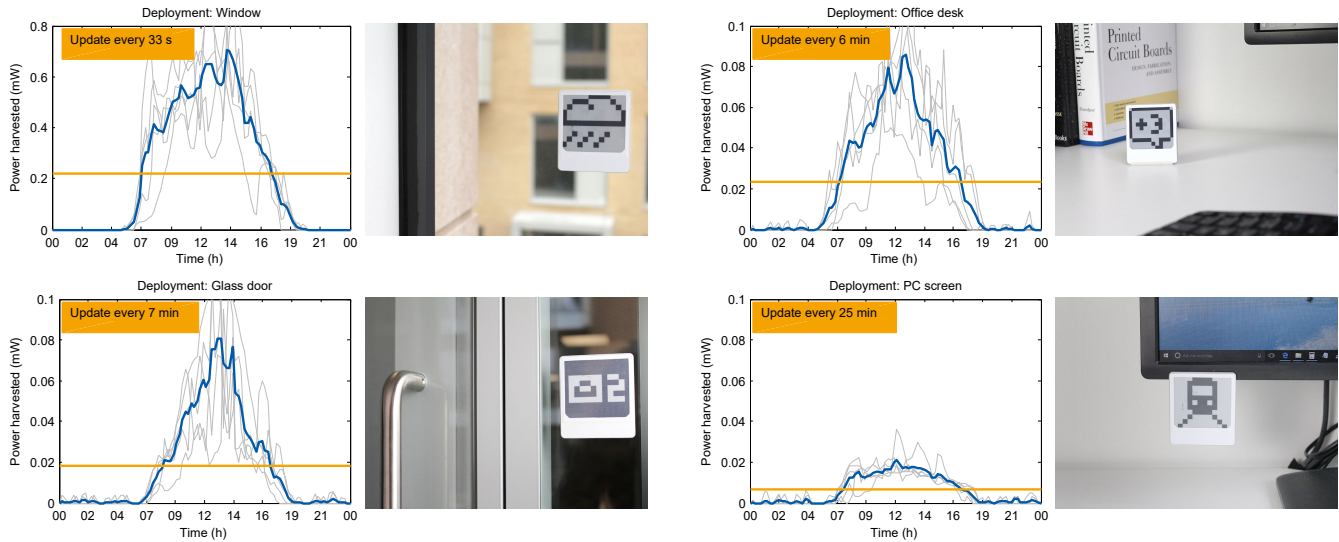

Figure 7. Four deployment scenarios result in varying energy harvesting opportunities. The solid blue line is the power available during the day averaged over 5 days (faint blue lines). The yellow line depicts the average power available across the entire period; this results in potential display updates every 30 s - 25 min.

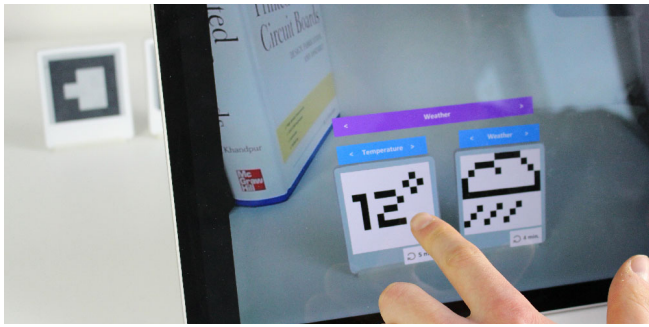

Figure 8. Our ultra-low power displays cannot show detailed information and are not interactive. To overcome this, a high-resolution interactive interface on a smartphone or tablet can be used. We prototyped an augmented reality system which uses a 2D barcode rendered on each display to overlay highly interactive and detailed content.

out using the radio. A memory-based update would require approximately 10% of the power of a network-based update.

Due to the self-powered nature of our displays, it is feasible to embed many devices in a user’s environment. Configuring and managing a multitude of displays could be cumbersome and error-prone — especially given that they react too slowly for interactive setup. One solution to this problem could be to use augmented reality (AR) to present an interactive overlay via a mobile device like a smartphone or tablet. The large pixels used in our prototype lend themselves well to fiducial-based visual tracking, and we have prototyped this concept as shown in Figure 8. This overlay could provide a means to configure the display as well as show additional information that augments the limited resolution of the displays themselves. For example, a weather display which shows only the outside temperature could be complemented with more detailed forecast information. NFC-based tagging would be another viable technique for a tag to uniquely identify itself and the content it is displaying to a mobile device.

The current implementation of our displays is constrained in that the rear of the device cannot be covered due to the PV cell. Recent developments in transparent PV cells however show that harvesting energy from the front of the display using invisible light spectra is feasible [35, 40] and this is something we would like to explore. It will also be valuable to carry out more experiments with exact light-level data to understand the inefficiencies in our system better and optimize the design. In some cases, it might be feasible to embed smaller solar panels into the front bezel instead.

To summarize, we have investigated and presented what we see as the three main dimensions in the design space for energy-harvesting situated displays: energy sources, display technologies and wireless communications. Based on our analysis, we implemented a thin, sticker-like situated display that uses a unique combination of PV harvesting, e-paper display technology, and BLE communications. A detailed evaluation of energy consumption shows that low-resolution (but large pixel) e-paper displays represent a new opportunity to achieve a high number of updates using a very constrained energy budget. Our 132-pixel prototype exhibits a 35 times lower power consumption and has a 78 % larger display area, compared to an active-matrix display with 46k pixels [4].

Although this type of display is not, to our knowledge, available commercially, we described how we made our own displays based on a standard PCB substrate. Hardware design details are provided to enable other researchers to replicate and build upon our work. By evaluating different locations, for example on a desk or stuck to a desktop monitor, we show that the end-to-end performance of our system supports updates every 1 - 25 minutes, depending on lighting. Ultimately we hope that our work is the next step towards more ubiquitous displays throughout the environment which help users to stay productive and informed.

REFERENCES

1. AllAboutWindowsPhone. Nokia Glance Screen and display settings on the Nokia Lumia 925, 2013. http://allaboutwindowsphone.com/features/item/17736_Nokia_Glance_Screen_and_displa.php (date accessed: 2016/04/12).
2. BBC. London bus stops embrace e-paper, 2015. <http://www.bbc.co.uk/news/technology-35162689> (date accessed: 2016/04/12).
3. Comiskey, B., Albert, J. D., Yoshizawa, H., Jacobson, J., by Michaels, C., and Others. An electrophoretic ink for all-printed reflective electronic displays. *Nature* 394 (1998), 253–255.
4. Dementyev, A., Gummeson, J., Thrasher, D., Parks, A., Ganesan, D., Smith, J. R., and Sample, A. P. Wirelessly powered bistable display tags. In *Proceedings of the 2013 ACM International Joint Conference on Pervasive and Ubiquitous Computing*, UbiComp '13, ACM (2013), 383–386.
5. Dementyev, A., Hodges, S., Taylor, S., and Smith, J. Power consumption analysis of bluetooth low energy, zigbee and ant sensor nodes in a cyclic sleep scenario. In *Wireless Symposium (IWS), 2013 IEEE International* (April 2013), 1–4.
6. E Ink. E Ink Aurora Imaging Film, 2013. http://www.eink.com/sell_sheets/aurora_spec_sheet_sept2013.pdf (date accessed: 2016/04/04).
7. E Ink. E Ink History, 2016. <http://eink.com/history.html> (date accessed: 2016/04/04).
8. Elliot, K., Neustaedter, C., and Greenberg, S. Time, ownership and awareness: The value of contextual locations in the home. In *Proceedings of Ubicomp 2005*, Springer (2005), 251–268.
9. FastCompany. Toshiba Unveils First Solar-Powered E-Reader, 2016. <http://www.fastcompany.com/1711567> (date accessed: 2016/04/04).
10. Gainspan Inc. GS1500M Wi-Fi Module, 2014. http://www.alphamicro.net/media/412417/gs1500m_datasheet_rev_1_4.pdf (date accessed: 2016/04/13).
11. Green, K. Programming Sharp Memory LCDs. http://www.sharpmemorylcd.com/resources/Programing_Memory_LCDs_AppNote.pdf (date accessed: 2016/07/21).
12. Japan Display Inc. Display Specification, 2015. http://www.j-display.com/english/news/2015/pdf/1.34inch_en.20150511_V1.1.pdf (date accessed: 2016/04/13).
13. Kappel, K., and Grechenig, T. "show-me": Water consumption at a glance to promote water conservation in the shower. In *Proceedings of the 4th International Conference on Persuasive Technology*, Persuasive '09, ACM (2009), 26:1–26:6.
14. Kawsar, F., Vermeulen, J., Smith, K., Luyten, K., and Kortuem, G. *Exploring the Design Space for Situated Glyphs to Support Dynamic Work Environments*. Springer Berlin Heidelberg, 2011, 70–78.
15. Kellogg, B., Talla, V., Gollakota, S., and Smith, J. R. Passive wi-fi: Bringing low power to wi-fi transmissions. In *13th USENIX Symposium on Networked Systems Design and Implementation (NSDI 16)*, USENIX Association (Mar. 2016), 151–164.
16. Kent Displays. 1/4 VGA Cholesteric Display Module with SPITM-Compatible Interface, 2016. https://www.sparkfun.com/datasheets/LCD/LCD-09559-25085b_320x240_SPI_datasheet.pdf (date accessed: 2016/07/21).
17. Kim, S. W., Kim, M. C., Park, S. H., Jin, Y. K., and Choi, W. S. Gate reminder: A design case of a smart reminder. In *Proceedings of the 5th Conference on Designing Interactive Systems: Processes, Practices, Methods, and Techniques*, DIS '04, ACM (2004), 81–90.
18. Kuznetsov, S., and Paulos, E. Upstream: Motivating water conservation with low-cost water flow sensing and persuasive displays. In *Proceedings of the SIGCHI Conference on Human Factors in Computing Systems*, CHI '10, ACM (2010), 1851–1860.
19. Lee, Y., Kim, G., Bang, S., Kim, Y., Lee, I., Dutta, P., Sylvester, D., and Blaauw, D. A modular 1mm³ die-stacked sensing platform with optical communication and multi-modal energy harvesting. In *2012 IEEE International Solid-State Circuits Conference* (Feb 2012), 402–404.
20. Nehani, J., Brunelli, D., Magno, M., Sigrist, L., and Benini, L. An energy neutral wearable camera with epd display. In *Proceedings of the 2015 Workshop on Wearable Systems and Applications*, WearSys '15, ACM (2015), 1–6.
21. OED Technologies. ComFlec O-Paper Imaging Film for Segmented Displays , 2016. <http://www.oedtech.com/> (date accessed: 2016/04/04).
22. O'Hara, K., Perry, M., and Churchill, E. *Public and Situated Displays: Social and Interactional Aspects of Shared Display Technologies*. Springer, 2003.
23. O'Hara, K., Perry, M., and Lewis, S. Social coordination around a situated display appliance. In *Proceedings of the SIGCHI Conference on Human Factors in Computing Systems*, CHI '03, ACM (2003), 65–72.
24. Oregon Scientific. +ECO Clima Control, 2009. <http://www.oregonscientific.com/manual/RMR500ES.pdf> (date accessed: 2016/04/04).
25. Paradiso, J. A., and Starner, T. Energy scavenging for mobile and wireless electronics. *IEEE Pervasive Computing* 4, 1 (Jan 2005), 18–27.
26. Parks, A. N., Kellogg, B., and Smith, J. R. Perpetual smart signage using ambient energy harvesting [poster abstract]. In *ACM International Symposium on Pervasive Displays* (2013).

27. Parks, A. N., Zhao, Y., and Smith, J. R. A wireless sensing platform utilizing ambient rf energy. *IEEE WiSNET, Austin TX* (2013).
28. Pedersen, E. R. People presence or room activity supporting peripheral awareness over distance. In *Proceedings of CHI'98*, ACM Press (1998), 283–284.
29. Pervasive Displays. 2.7" Low Power Aurora Mb (V231), 2016. <http://www.pervasivedisplays.com/LiteratureRetrieve.aspx?ID=222072> (date accessed: 2016/04/04).
30. Qualcomm. Qualcomm Mirasol, 2016. <https://www.qualcomm.com/documents/mirasol-imod-tech-overview> (date accessed: 2016/07/22).
31. Roen, S. Solar powered portable calculator, Apr. 12 1977. US Patent 4,017,725.
32. Schuss, C., and Rahkonen, T. Solar energy harvesting strategies for portable devices such as mobile phones. In *2013 14th Conference of Open Innovations Association (FRUCT)* (Nov 2013), 132–139.
33. Senli, S. Ethernet energy harvesting. Master's thesis, KTH, School of Information and Communication Technology (ICT), Communication Systems, CoS., 2012.
34. Silicon Labs Inc. CP2400 Segment LCD Driver, 2010. <http://www.silabs.com/Support>(date accessed: 2016/04/13).
35. SUNPARTNER Technologies. Wysips Reflective, 2016. <http://sunpartnertechnologies.com/mobile-devices/> (date accessed: 2016/04/04).
36. Sweeney, D., Chen, N., Hodges, S., and Grosse-Puppenthal, T. Displays as a material: A route to making displays more pervasive. *IEEE Pervasive Computing* 15, 3 (July 2016), 77–82.
37. Talla, V., Kellogg, B., Ransford, B., Naderiparizi, S., Gollakota, S., and Smith, J. R. Powering the next billion devices with wi-fi. *CoRR abs/1505.06815* (2015).
38. Texas Instruments. BQ25570 Nano Power Boost Charger and Buck Converter for Energy Harvester Powered Applications, 2016. <http://www.ti.com/product/bq25570> (date accessed: 2016/07/21).
39. TI Inc. CC3100MOD SimpleLink, 2014. <http://www.ti.com/lit/ds/symlink/cc3100mod.pdf> (date accessed: 2016/04/13).
40. Ubiquitous Energy. clearview power Technology, 2016. <http://ubiquitous.energy/> (date accessed: 2016/04/04).
41. Warneke, B. A., Scott, M. D., Leibowitz, B. S., Zhou, L., Bellew, C. L., Chediak, J. A., Kahn, J. M., Boser, B. E., and Pister, K. S. J. An autonomous 16 mm³ solar-powered node for distributed wireless sensor networks. In *Sensors, 2002. Proceedings of IEEE*, vol. 2 (2002), 1510–1515 vol.2.
42. Winstar Display Co. Ltd. 2.7-inch (diagonal) Memory LCD. <http://www.sharpmemorylcd.com/2-7-inch-memory-lcd.html> (date accessed: 2016/04/13).
43. Zhao, Y., Smith, J. R., and Sample, A. Nfc-wisp: An open source software defined near field rfid sensing platform. In *Adjunct Proceedings of the 2015 ACM International Joint Conference on Pervasive and Ubiquitous Computing and Proceedings of the 2015 ACM International Symposium on Wearable Computers, UbiComp/ISWC'15 Adjunct*, ACM (2015), 369–372.