

A flow-map model for analyzing pseudothresholds in fault-tolerant quantum computing

Krysta M. Svore

*Columbia University, Dept. of Computer Science, 1214 Amsterdam Ave. MC:0401
New York, NY 10027*

Andrew W. Cross

*Massachusetts Institute of Technology, Dept. of Electrical Engineering, 77 Massachusetts Ave.
Cambridge, MA 02139*

Isaac L. Chuang

*Massachusetts Institute of Technology, Dept. of Electrical Engineering, 77 Massachusetts Ave.
Cambridge, MA 02139*

Alfred V. Aho

*Columbia University, Dept. of Computer Science, 1214 Amsterdam Ave. MC:0401
New York, NY 10027*

Received (received date)

Revised (revised date)

An arbitrarily reliable quantum computer can be efficiently constructed from noisy components using a recursive simulation procedure, provided that those components fail with probability less than the fault-tolerance threshold. Recent estimates of the threshold are near some experimentally achieved gate fidelities. However, the landscape of threshold estimates includes pseudothresholds, threshold estimates based on a subset of components and a low level of the recursion. In this paper, we observe that pseudothresholds are a generic phenomenon in fault-tolerant computation. We define pseudothresholds and present classical and quantum fault-tolerant circuits exhibiting pseudothresholds that differ by a factor of 4 from fault-tolerance thresholds for typical relationships between component failure rates. We develop tools for visualizing how reliability is influenced by recursive simulation in order to determine the asymptotic threshold. Finally, we conjecture that refinements of these methods may establish upper bounds on the fault-tolerance threshold for particular codes and noise models.

Keywords: Fault-Tolerance

Communicated by: to be filled in by the Editorial

1 Introduction

A quantum computer can potentially solve certain problems more efficiently than a classical computer [1, 2, 3]. However, quantum computers are likely to be engineered from inherently noisy components, so any scalable quantum computer system will require quantum error correction and fault-tolerant methods of computation. As candidate quantum device technologies mature, we need to determine component failure probabilities necessary to achieve scalability. The fault-tolerance threshold for gate and memory components is particularly interesting because arbitrarily reliable computations are possible if the circuit components have failure rates below the threshold. Given detailed knowledge of the fault-tolerance thresh-

old and its associated trade-offs, proposals for fault-tolerant quantum computation can be critically evaluated.

The concept of a fault-tolerance threshold has its origins in the classical theory of computation. In the 1950's, von Neumann showed that it is possible to achieve a reliable classical computation with faulty components provided that the failure probability of each component is below some constant threshold probability that is independent of the circuit size and the desired noise rate [4]. Similarly, concatenated coding and recursive error correction can be used to achieve reliable quantum computation. Concatenation is the process of encoding physical bits of one code as logical bits of another code. It is now well-known that using a single-error-correcting concatenated coding scheme with L levels of recursion, the maximum failure probability $\gamma_{circuit}$ of a fault-tolerant circuit can be estimated as a function of the maximum failure probability γ of a basic component using the *fault-tolerance threshold inequality*

$$\frac{\gamma_{circuit}(\gamma)}{\gamma_{th}} \leq \left(\frac{\gamma}{\gamma_{th}} \right)^{2^L}, \quad (1)$$

where γ_{th} is the asymptotic threshold [5]. When Eq (1) holds with equality, we call it the *fault-tolerance threshold equation*. The final circuit failure probability $\gamma_{circuit}$ decreases as a doubly exponential function of L if $\gamma < \gamma_{th}$.

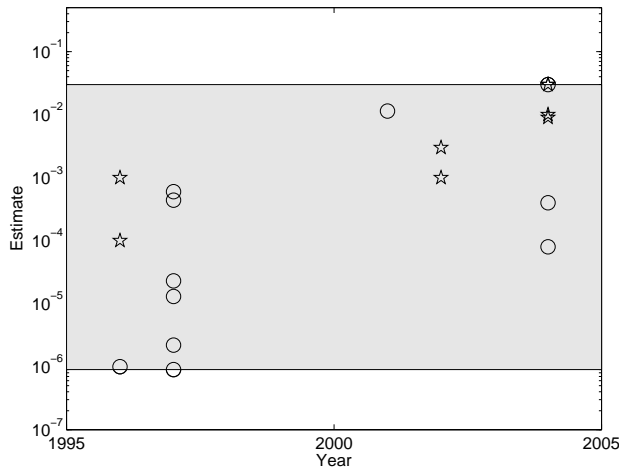

Fig. 1. Plots of quantum threshold estimates for stochastic noise models between the years 1996 and 2004 [5, 6, 7, 8, 9, 10, 11, 12, 13, 14, 15]. Stars denote numerical estimates and circles denote all others. Most of these estimates apply to the $[[7, 1, 3]]$ code, though the pair of thresholds at and above 10^{-2} apply to surface code memories and post-selected quantum computation. The networks vary over unitary networks, nearest-neighbor networks, and various optimized networks. Some estimates apply only when there are no memory errors, and others apply only for the Clifford-group gates. The dark swath designates the large interval that contains all of these estimates.

One branch of fault-tolerant quantum computing research has focused on estimating the fault-tolerance threshold in the fault-tolerance threshold inequality. Figure 1 shows the range of quantum threshold estimates reported in [5, 6, 7, 8, 9, 10, 11, 12, 13, 14, 15]. The estimates, which vary between 10^{-6} and 10^{-2} , include numerical and analytical results for varying networks for the $[[7, 1, 3]]$ code, such as optimized networks, unitary networks, and nearest-neighbor networks. They also include results for surface code memories and post-selected quantum computing models that yield thresholds above 10^{-2} . Numerical estimates tend to be more optimistic than their analytical counterparts.

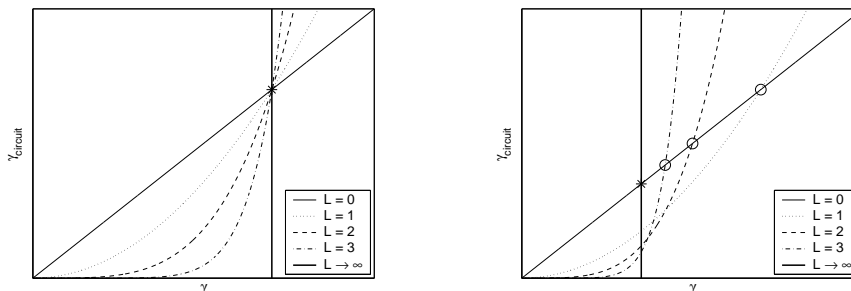

Fig. 2. (a) An ideal threshold reliability information plot (TRIP) follows Eq (1). The crossing point between the $L = 0$ line and the $L = 1$ curve, marked by the asterisk on the thick vertical line, is the fault-tolerance threshold. All of the curves cross at the same point. (b) A real TRIP does not follow Eq (1). The crossing points between the $L = 0$ line and the other curves are all different. These points, marked by circles, correspond to a sequence of pseudothresholds that converges to the real fault-tolerance threshold marked by the asterisk on the thick vertical line.

If there is a single type of component that is replaced using the same rule each time, the fault-tolerance threshold inequality, Eq (1), becomes an equality. This leads to a very simple prediction shown in Figure 2(a): if $\gamma = \gamma_{th}$, then $\gamma_{\text{circuit}} = \gamma_{th}$. This fact is taken as the basis of several numerical analyses of the fault-tolerance threshold today. Specifically, this simplification is attractive for computationally expensive numerical simulations because it implies that the threshold can be determined by finding the smallest nonzero value of γ that solves $\gamma_{\text{circuit}}(\gamma) = \gamma$.

Realistically, however, there are multiple types of components that are each replaced using different rules, so the first crossing point does not accurately indicate the fault-tolerance threshold. Figure 2(b) more accurately portrays the effect of recursive simulation. As the recursion level increases, for example, an exponentially growing number of wires must be introduced between gates. When these wires are unreliable, as they likely will be in quantum circuits, successive recursion levels can cause errors to increase even though γ is beneath the apparent threshold. Thus, recursive simulation changes the relative proportions of each type of component and what appears to be the threshold at one level of recursion may be far from the asymptotic threshold. This sequence of crossing points cannot be used to describe the proper conditions under which a system is scalable. Rather, these crossing points are pseudothresholds [6].

When multiple types of components are replaced using different rules, each component type must be parameterized by a separate failure probability. Hence, opportunity exists for engineering trade-offs that still preserve scalability. These trade-offs can be quantified given the asymptotic threshold, families of pseudothresholds, and their relation to the shape of the set of subthreshold component parameters.

In this paper, we present practical methods for distinguishing pseudothresholds from asymptotic thresholds. In particular, we explore the conditions under which pseudothresholds exist and clarify their meaning. We embark on this exploration carrying two tools. The first tool is a generalization of Figure 2(b), which we call the *threshold reliability information plot* (TRIP). In a TRIP, each curve represents the failure probability of a particular component at concatenation level L and crosses the $L = 0$ line once. The crossing of a level- L curve and the level- $(L = 0)$ line yields the rightmost edge of an interval on the γ -axis below which reliability is improved by concatenation. The crossing point is a level- L pseudothreshold.

The second tool is a *threshold information flow diagram* (TIFD) that shows how recursive simulation can change the reliability of a particular set of noisy components. A *flow* is a normalized vector field that can be visualized as a collection of arrows. Each arrow's base is anchored to a point that represents the current failure probability of the (composite)

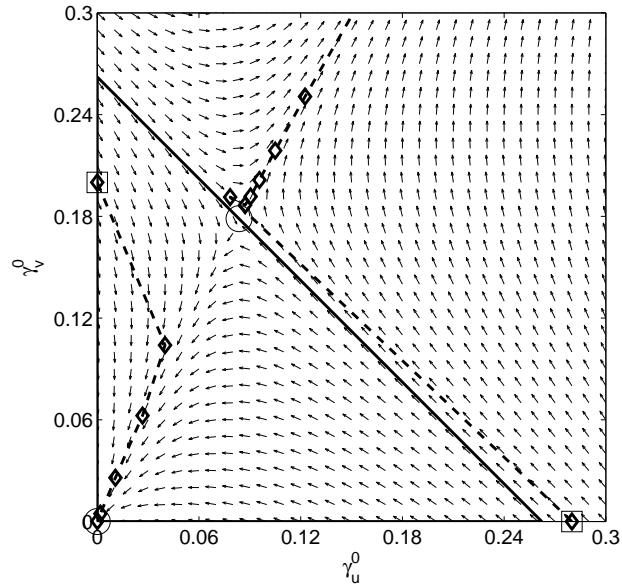

Fig. 3. Threshold information flow diagram (TIFD) corresponding to the following recursive simulation procedure: gates u and v at level- $(L - 1)$ are both replaced by fault-tolerant gates at level L that can withstand a single level- $(L - 1)$ gate failure. However, u and v compute different functions, so their fault-tolerant implementations are different. In this example, the fault-tolerant u contains two u gates and two v gates, and the fault-tolerant v contains three u gates and three v gates. Arrows on this TIFD indicate how the recursive simulation procedure changes the effective failure probabilities of u and v . For some failure probabilities, recursive simulation has no effect. These fixed points are marked by circles, and one of them determines the fault-tolerance threshold, indicated by a thick black line. Sample trajectories begin at the squares and flow along the thick dashed lines, where the diamonds mark the sequence of points for each level L of concatenation.

components. The direction of each arrow indicates the direction the anchor point moves at the next level of recursion. In contrast to the TRIP, the TIFD exposes how all of the component failure probabilities change in a recursive simulation. If the recursive simulation is self-similar, i.e., if the failure probability of a level- L component can be expressed in terms of the failure probabilities of level- $(L - 1)$ components, particularly with respect to the noise model, then the TIFD indicates whether or not recursive simulation increases or decreases each component's failure probability, allowing us to compute and visualize the fault-tolerance threshold.

For example, Figure 3 shows a TIFD for a hypothetical pair of faulty basic gates u and v . Because u and v compute different functions, their fault-tolerant implementations use different numbers of basic u and v gates. In this example, the fault-tolerant u contains two u gates and two v gates, connected in some fashion so that the fault-tolerant u can withstand one internal gate failure and still produce a “good” output. If basic gates u and v fail independently with probabilities γ_u and γ_v , respectively, then the failure probability of the fault-tolerant u gate is

$$1 - (1 - \gamma_u)^2(1 - \gamma_v)^2 - 2\gamma_u(1 - \gamma_u)(1 - \gamma_v)^2 - 2\gamma_v(1 - \gamma_v)(1 - \gamma_u)^2. \quad (2)$$

Similarly, the fault-tolerant v gate contains three u gates and three v gates and can withstand any single failure, giving

$$1 - (1 - \gamma_u)^3(1 - \gamma_v)^3 - 3\gamma_u(1 - \gamma_u)^2(1 - \gamma_v)^3 - 3\gamma_v(1 - \gamma_v)^2(1 - \gamma_u)^3. \quad (3)$$

There are many such hypothetical examples. In Section 3, we give a more realistic example that demonstrates how a TIFD is calculated based on an actual circuit.

Continuing with this example, the effective failure probabilities of u and v after level-1 recursive simulation both depend on the initial failure probabilities γ_u^0 and γ_v^0 of u and v , shown on the horizontal and vertical axes of the TIFD. Consider the following scenario. The v gate initially fails with probability 0.2 and the u gate does not fail at all. A square marks this point on the TIFD. The arrow at this point on the TIFD points down and to the right, indicating that a level-1 recursive simulation will improve v but make u worse. The dashed line connects the initial failure probabilities to the failure probabilities of the level-1 simulated gates (at about (0.04, 0.1)). The dashed path shows that subsequent recursive simulation makes u and v arbitrarily reliable.

The TIFD in Figure 3 also indicates the set of initial failure probabilities that is below threshold. The boundary of this set is determined by a fixed point of the recursive simulation procedure. This fixed point is marked with a circle, and the thick dark line passing through this circle is the invariant set that indicates the fault-tolerance threshold. For example, an ideal v gate and a u gate that initially fails with probability 0.28 (marked by a square) is above threshold. This point flows nearly parallel to the invariant line at first, but ultimately escapes from the boundary of the TIFD after about 7 levels of recursive simulation.

We organize the paper as follows. In Section 2, we first define the fault-tolerance threshold for concatenated flow maps, then we define pseudothresholds and describe their importance. We calculate, in Section 3, a family of pseudothresholds and distinguish them from the fault-tolerance threshold estimate for the classical repetition code. In Section 4, we study the $[[7, 1, 3]]$ CSS code, again comparing the fault-tolerance threshold against families of pseudothresholds. We suggest techniques for finding the threshold in Section 5 that expand upon our use of the TIFD. We conclude in Section 6 with open questions.

2 Pseudothresholds

In Section 1, we discussed the phenomenon of pseudothresholds without introducing many mathematical concepts. In this section, we clarify what we mean by defining both the fault-tolerance threshold and the pseudothreshold sequences for a set of flow maps.

2.1 The fault-tolerance threshold

The threshold is related to the number of “bad” fault paths through a circuit. Assume faults occur at discrete locations and times with probability dependent on the location type. The failure probability of the circuit can then be determined as a function of failure probabilities of types of locations. For a code correcting t errors, the probability that one of these

bad fault paths occurs is no more than $C\gamma^{t+1}$, where γ is the largest failure probability of any type of location in the circuit and C is the number of ways to choose $t+1$ failed locations out of N total locations. The fault-tolerance threshold satisfies

$$\gamma_{th} \geq \left(\frac{1}{C}\right)^{1/(t+1)}, \quad (4)$$

since γ_{th} is the fixed point of the map $\gamma_{circuit}(\gamma) = C\gamma^{t+1}$.

However, we must recognize that the fault-tolerant implementations of each location type differ, so we must express the failure probability of each fault-tolerant location type as a function of the location types it contains. In other words, we construct (approximations to) the *flow maps* for the given fault-tolerant implementations and noise model [6, 9]. In particular, if each type of location ℓ is assigned an initial failure probability γ_ℓ^0 and if there are n different types of locations, the approximate failure probability of location type ℓ after one level of recursive simulation is a function Γ_ℓ^1 of all n of the initial failure probabilities. Therefore, Γ_ℓ^1 is called the *flow map for location type ℓ* .

Considering all types of locations l , the functions Γ_ℓ^1 are the coordinates of a *flow map* Γ^1 . The flow map takes the failure probabilities of the n location types to their new values after one level of recursive simulation. The failure probabilities of the L -simulated location types are (approximately) related to the initial failure probabilities γ_ℓ^0 by the composed flow map,

$$\Gamma^L \approx \underbrace{\Gamma^1 \circ \dots \circ \Gamma^1}_{L \text{ times}}. \quad (5)$$

Ideally, the replacements can be constructed so that Eq (5) is an equality. This is the case for the example in Section 3 but not in Section 4. Let Γ_ℓ^L denote the coordinate function of Γ^L associated with location ℓ , and let Γ_ℓ^0 be the initial function that selects the ℓ coordinate. In other words, Γ_ℓ^L is the failure probability of location ℓ after L levels of recursive simulation. The function Γ_ℓ^L is a *concatenated flow map for location type ℓ* because we can use Eq (5) to derive (an approximation to) Γ_ℓ^L . The map Γ^L is the *concatenated flow map*.

A vector of failure probabilities $\vec{\gamma}$ for the n location types is *below threshold* if all n of the failure probabilities approach zero as the concatenation level approaches infinity,

$$\lim_{L \rightarrow \infty} \Gamma^L(\vec{\gamma}) = \vec{0}. \quad (6)$$

Let T be the set of these vectors that are below threshold, and let C_ϵ be the n -dimensional cube of edge length ϵ with one corner at the origin,

$$C_\epsilon \equiv \{\vec{\gamma} \in [0, 1]^n \mid \gamma_\ell < \epsilon \ \forall \ell, \epsilon \in (0, 1]\} \quad (7)$$

The cube contains all of the vectors whose worst failure probability is less than ϵ . The *fault-tolerance threshold* or *asymptotic threshold* is the size of the largest cube contained in T , i.e.,

$$\gamma_{th} \equiv \sup\{\epsilon \geq 0 \mid C_\epsilon \subseteq T\}. \quad (8)$$

If all component failure probabilities are beneath this probability, then composing the flow maps reduces the failure probability arbitrarily close to zero.

2.2 Definition of pseudothresholds

Before we define pseudothresholds, we introduce the concept of a *setting*. Settings parameterize a set of location failure probabilities by a single parameter so that we can think of Γ_ℓ^L as a function of this parameter. A setting is a function from a single failure probability parameter to a vector of n failure probabilities, one for each location. For example, the *diagonal setting* $g(\gamma) = (\gamma, \dots, \gamma)$ is used in analyses that assign each location the same initial

failure probability. The *Steane setting* $g(\gamma)$ is another setting that sets all location failure probabilities to γ except for a waiting bit which is assigned $\gamma/10$ [14] (in this reference, a waiting bit is assigned a failure probability of $\gamma/100$).

Suppose there are n types of locations. We define a pseudothreshold $\gamma_{\ell,g}^L$ for a fixed level of recursion $L > 0$, a location ℓ , and a setting g as the least nonzero solution to

$$\Gamma_{\ell}^L(g(\gamma)) = \gamma, \quad (9)$$

This definition presents the (L, ℓ, g) -pseudothreshold as a fixed-point calculation for a function derived from the flow map Γ . The left-hand side of Eq (9) can be viewed as one of the curves plotted in Figure 2(a), and the right hand side can be viewed as the $L = 0$ line. The point where these curves intersect is a pseudothreshold.

For fixed location ℓ and setting g , the sequence $\gamma_{\ell,g}^L$ is not necessarily constant as a function of L . In fact, the sequence is typically not constant, meaning that pseudothresholds are a generic phenomenon. More specifically, let γ_0 be any pseudothreshold of the flow map Γ for a setting g , and let $\vec{\gamma}_0$ be the constant vector $(\gamma_0, \dots, \gamma_0)$. The pseudothreshold γ_0 is independent of location type and recursion level only if the setting satisfies $\Gamma(g(\vec{\gamma}_0)) = \vec{\gamma}_0$ and $\vec{\gamma}_0$ is a fixed point of Γ .

Despite the fact that pseudothresholds are not thresholds, pseudothresholds are interesting because only a fixed level of recursive simulation will be used in practice. If the goal is to construct a reliable fault-tolerant location type ℓ , and all of the location types have the same initial reliability (i.e., $g(\gamma) = (\gamma, \dots, \gamma)$), then choosing γ to be less than the (L, ℓ, g) -pseudothreshold makes the L -simulated gate location type ℓ more reliable than the initial gate. However, some caution must be applied to pseudothresholds as well because the $(1, \ell, g)$ -pseudothreshold and the $(2, \ell, g)$ -pseudothreshold can be substantially different.

In the following sections, we present an illustrative example of classical pseudothresholds followed by a more detailed example of quantum pseudothresholds. We show by means of these examples that pseudothresholds are generic to all multiparameter maps. In addition, we highlight that threshold estimates should account for multiple location types and higher levels of code concatenation to achieve more realistic threshold results.

3 Classical Pseudothresholds for the [3, 1, 3] Code

In this section, we analyze a classical example to build intuition about the differences between pseudothresholds and thresholds. We study pseudothresholds for classical fault-tolerant components based on the [3, 1, 3] repetition code. We use the threshold reliability information plot (TRIP) of the [3, 1, 3] code to identify pseudothresholds. We then characterize the flow map for this example using a threshold information flow diagram (TIFD).

3.1 The [3, 1, 3] code and its failure probability map

In this example, the classical single-error-correcting [3, 1, 3] repetition code, also called triple modular redundancy (TMR), is used to encode a single bit in three bits by copying it three times. To make a fault-tolerant classical wire using this code, three location types $\Omega = \{w, v, f\}$ are required, where

- $w : \{0, 1\} \rightarrow \{0, 1\}$ defined by $w(a) = a$ is a *wire*.
- $v : \{0, 1\}^3 \rightarrow \{0, 1\}$ defined by $v(a, b, c) = ab \oplus bc \oplus ca$ is a *voter*.
- $f : \{0, 1\} \rightarrow \{0, 1\}^3$ defined by $f(a) = (a, a, a)$ is a *fanout*.

The superscripts above indicate the Cartesian product. The wire w is analogous to a waiting bit in a quantum fault-tolerance analysis, and the voter v and fanout f perform error correction.

A noisy version of each location type is defined as follows. A noisy wire flips the output bit with probability γ_w . A noisy voter incorrectly indicates the output bit with probability γ_v . For simplicity, we choose to model the fanout gate to be noiseless.

To recursively construct a fault-tolerant wire, *replacement rules* are used. A replacement rule is a pair $(b, R(b))$ where $b \in \Omega$ and $R(b)$ is a circuit over Ω that specifies how to replace a level- $(L - 1)$ location at level L . $R(b)$ is called the *replacement* of b and must preserve the functionality of the original location b . We construct the replacement rules to mirror replacement rules for quantum circuits, in which a circuit location is replaced by error correction followed by a fault-tolerant implementation of the location.

The following steps suggest how to ensure proper component connectivity for a code encoding a single bit. First, replace b directly by $D^{\otimes n_o} \circ R(b) \circ E^{\otimes n_i}$ where D and E are an ideal decoder and encoder. We must have $D \circ E$ equal to the identity gate on a single bit, where the open circle \circ denotes function composition. The numbers n_i and n_o are the number of input and output bits of b , respectively. After replacing each component in this manner, make a second pass over the circuit and replace all pairs $D \circ E$ by bundles of wires. Finally, replace the remaining encoders and decoders by respective fault-tolerant implementations of input preparation and output readout. The resulting circuit components will be properly connected, and the circuit will not contain decoding and re-encoding components since these components are not typically fault-tolerant.

For this example, a wire w is replaced by error correction followed by a transversal implementation of the wire, i.e., a wire is applied to each bit of the encoded input, shown in Figure 4. Note the first dashed box indicates the classical error correction, which involves w , v , and f location types, and the second dashed box indicates the fault-tolerant implementation of the original location. Similarly, Figures 5(a) and 5(b) show the fault-tolerant replacement of v and f , respectively.

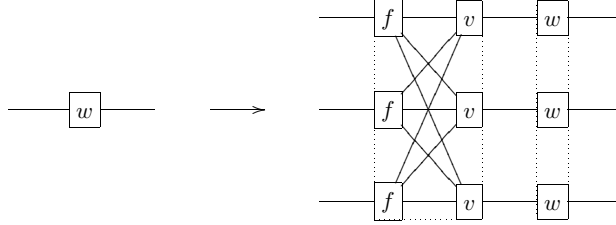

Fig. 4. Replacement rule for a wire w . The fanouts f and voters v perform error correction. The first dashed box indicates classical error correction using fanouts f and voters v . The second dashed box indicates the fault-tolerant implementation of the wire w .

Using the replacements $R(w)$ and $R(v)$, the failure probabilities $\Gamma_w^1(\vec{\gamma})$ and $\Gamma_v^1(\vec{\gamma})$ can be found, where the initial vector of failure probabilities is $\vec{\gamma} = (\gamma_w^0, \gamma_v^0)$. Failure is defined to occur when the component's output does not decode to the correct value. The wire failure probability is easily calculated by counting the number of ways each configuration of errors occurs. For example, three voters fail in one way, three voters and one wire fail in three ways, two voters fail in three ways, etc. Rewriting the resulting polynomial in distributed form gives

$$\begin{aligned} \Gamma_w^1(\vec{\gamma}) &= 6\gamma_v\gamma_w + 3\gamma_v^2 + 3\gamma_w^2 - 2\gamma_v^3 - 18\gamma_v^2\gamma_w + 12\gamma_v^3\gamma_w - 18\gamma_v\gamma_w^2 \\ &\quad + 36\gamma_v^2\gamma_w^2 - 24\gamma_v^3\gamma_w^2 - 2\gamma_w^3 + 12\gamma_v\gamma_w^3 - 24\gamma_v^2\gamma_w^3 + 16\gamma_v^3\gamma_w^3, \end{aligned} \quad (10)$$

where the superscript 0 has been dropped for notational convenience.

Replacing the wire failure probability γ_w^0 by γ_v^0 and the voter failure probability γ_v^0 by the probability of error correction failure $3(\gamma_v^0)^2(1 - \gamma_v^0) + (\gamma_v^0)^3$ gives

$$\begin{aligned} \Gamma_v^1(\vec{\gamma}) &= 3\gamma_v^2 + 16\gamma_v^3 - 39\gamma_v^4 - 126\gamma_v^5 + 474\gamma_v^6 - 288\gamma_v^7 - 936\gamma_v^8 \\ &\quad + 2080\gamma_v^9 - 1824\gamma_v^{10} + 768\gamma_v^{11} - 128\gamma_v^{12}, \end{aligned} \quad (11)$$

where the superscript has been dropped again in the last expression.

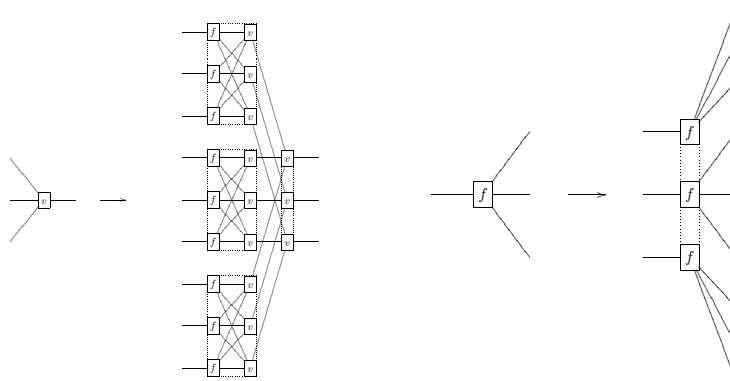

Fig. 5. (a) Replacement rule for a voter v . The first dashed box indicates classical error correction using fanouts f and voters v . The second dashed box indicates the fault-tolerant implementation of the voter v . (b) Replacement rule for a fanout f . Because we assume fanouts are noiseless, the replacement is just three fanout gates f .

The flow maps Eq (10) and Eq (11) are exact and satisfy Eq (5) with equality, so they contain enough information to determine the asymptotic threshold. They can also be used to determine a bound on the number of “bad” fault paths, as discussed in Section 2, by considering only the low-order terms in the flow maps:

$$\Gamma_w^1(\vec{\gamma}) \leq 3\gamma_w^2 + 3\gamma_v^2 + 6\gamma_w\gamma_v \quad (12)$$

$$\Gamma_v^1(\vec{\gamma}) \leq 3\gamma_v^2 + 16\gamma_v^3 = (3 + 16\gamma_v)\gamma_v^2. \quad (13)$$

These bounds clarify the relative contribution each component makes to the failure probability of a fault-tolerant component. They also suggest a conservative bound of $1/12$ on γ_{th} . This can be calculated by assuming that $\gamma_v = \gamma_w$, solving for the fixed point of the right hand side of each inequality, and taking the least such fixed point.

3.2 TRIPs for the [3,1,3] code

What is the behavior of the wire and voter failure probabilities as the concatenation level L increases? TRIPs based on Eqs (10)–(11) provide a visualization of each level crossing point for the two types of locations.

Figures 6 and 7 are TRIPs for the voter and wire locations, respectively. From Figure 6, it is clear the voter probability $\Gamma_v^1(\vec{\gamma})$ is a one-parameter map, and thus should resemble the TRIP for the fault-tolerance threshold equation (Figure 2(a)). Since $\Gamma_v^1(\vec{\gamma})$ is a function of only γ_v^0 for all L , each $\Gamma_v^L(\vec{\gamma})$ intersects at the same fixed-point of the map. This fixed point γ_{th} , indicated by a thick vertical line, is the $L = \infty$ pseudothreshold and the asymptotic threshold. It occurs at approximately 0.246. Note that the $L = \infty$ pseudothreshold for a particular location and the asymptotic threshold are not always equal, but they happen to be in this example.

Even for a classical setting, there is a difference between pseudothresholds and the asymptotic threshold γ_{th} . Figure 7 shows the TRIP for the wire location at levels $L = 0, 1, 2, 3, \infty$. Here, unlike in the TRIP for the voter location, pseudothresholds appear in addition to an asymptotic threshold. This is because the replacement $R(w)$ for a wire includes locations of type w, v , and f , creating a two-parameter map (fanouts are noiseless) that exhibits changing behavior with each concatenation level L . The curves now cross the $L = 0$ line at different points. Each of these crossing points in the TRIP is a level- L pseudothreshold. As we

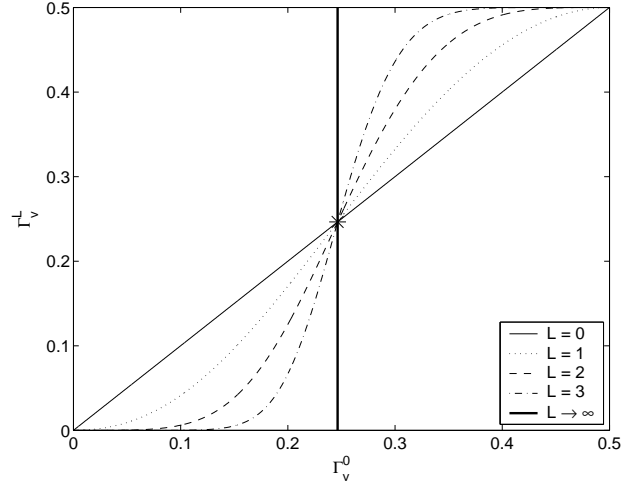

Fig. 6. TRIP for a voter location for the $[3, 1, 3]$ code for $L = 0, 1, 2, 3, \infty$. Because Γ_v^L is a function of only γ_v^0 constructed by recursive application of $R(v)$, all of the curves Γ_v^L intersect at the same point. This point is the fixed-point $\gamma_{th} \approx 0.246$ of the map and is indicated by an asterisk.

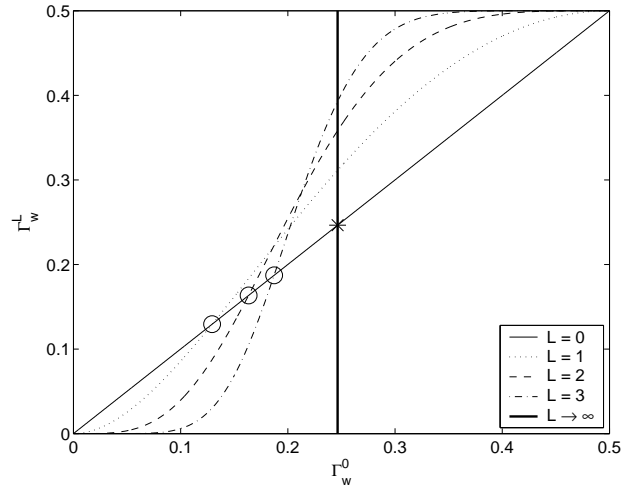

Fig. 7. TRIP for a wire location for the $[3, 1, 3]$ code for $L = 0, 1, 2, 3, \infty$ using the diagonal setting $\gamma_w^0 = \gamma_v^0$. Because Γ_w^L is a function of both γ_w^0 and γ_v^0 constructed by recursive composition, the curves Γ_w^L cross the $L = 0$ line at different points. Each of these points is a level- L pseudothreshold indicated by a circle, and the sequence of pseudothresholds $\gamma_w^1, \gamma_w^2, \dots$, converges to the fault-tolerance threshold $\gamma_{th} \approx 0.246$ indicated by an asterisk.

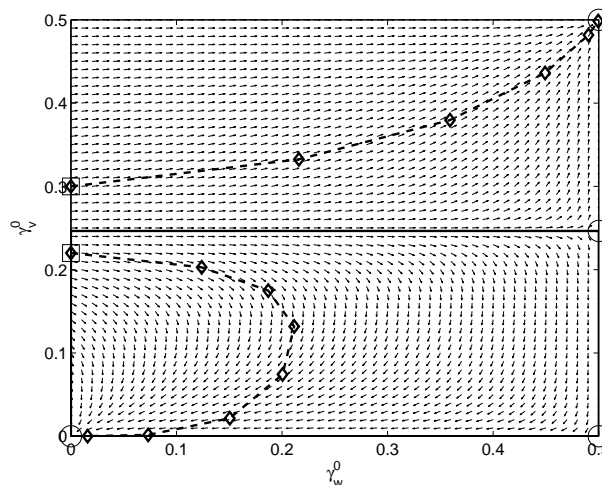

Fig. 8. TIFD for γ_w and γ_v for the $[3,1,3]$ code. The fixed points are indicated by circles. The region $[0, 1/2) \times [0, \gamma_{th})$ enclosed by a thick line is the set of points below threshold, where $\gamma_{th} \approx 0.246$. Two sample trajectories begin at the squares and flow along the thick dashed lines, where the diamonds indicate the sequence of points as L increases, toward $(0, 0)$ and $(1/2, 1/2)$.

repeatedly replace the wire using $R(w)$, the number of voter locations begins to dominate, so the crossing point approaches the voter threshold, which corresponds to the asymptotic threshold. The difference between the asymptotic threshold $\gamma_{th} \approx 0.246$ and the level-1 wire location pseudothreshold $\gamma_w^1 \approx 0.129$ is 0.117 , or $\gamma_{th} \approx 1.9 \times \gamma_w^1$.

3.3 TIFDs for the $[3,1,3]$ code

Given that pseudothresholds can be so different from γ_{th} , can γ_{th} be determined from just one application of the flow map? In Section 1, it was suggested that a TIFD provides an informative view of the effect of recursive simulation. Although a TRIP provides a visualization of the asymptotic behavior, it hides the fact that Γ^1 acts on a multidimensional space. When Γ^1 is chosen such that Eq (5) is an equality, Γ^1 contains all of the information about the flow since Γ^L can be expressed in terms of Γ^1 . A TIFD shows where each point flows under repeated application of Γ^1 without iterating the map explicitly.

In Figure 8, a TIFD for wire and voter failure probabilities on the unit half square is shown. The arrows represent the vectors $\Gamma^1(\vec{\gamma}) - \vec{\gamma}$, which give the probability flow under recursive simulation. There are five fixed points of the map: $(0, 0)$, $(1/2, 0)$, $(1/2, \gamma_{th})$, $(1/2, 1/2)$, and $(1, 0)$, where $\gamma_{th} \approx 0.246$ cannot be expressed in radicals. Circles mark four of these fixed points. The subthreshold region T is $[0, 1/2) \times [0, \gamma_{th})$, indicated by the thick black box. Three corners of the subthreshold region are fixed points of the map. The fault-tolerance threshold γ_{th} is the size of the largest “cube”, a square in this case, that is contained in the subthreshold region.

First, if $\gamma_w^0 = 0$ and $\gamma_v^0 > 0$, then the flow draws these points off of the γ_v^0 -axis. This occurs because the wire replacement rule $R(w)$ contains both voter and wire locations, so the failure probabilities “mix”. Second, if $\gamma_v^0 = 0$, then any point $\gamma_w^0 < 1/2$ flows to the origin because the voters amplify any bias toward success. Third, the voter failure probability $\Gamma_v^1(\vec{\gamma})$ is independent of γ_w^0 , so the voter probability is a simple one-parameter map under replacement. If $\gamma_v^0 < \gamma_{th}$, the map’s fixed point, then the voter probability flows toward the γ_w^0 -axis. Finally, if $\gamma_v^0 < \gamma_{th}$ and $\gamma_w^0 < 1/2$, then initially the wire failure probability may

increase because the voters are not reliably correcting errors. However, the voters improve with each iteration, so eventually this trend reverses. The voters begin correcting more errors than they introduce, and all of these points flow toward the origin.

For the classical $[3, 1, 3]$ code, the TIFD fully characterizes the threshold set T for three reasons. First, deviated inputs, i.e., inputs that are not codewords, are corrected before faults are introduced by the simulated gate locations. Second, the flow maps are the precise component failure probabilities. Third, there is no phase noise in classical fault-tolerance, so the parameters of the noise channel only change in the trivial way. Furthermore, the entire flow is easily visualized since the TIFD is two-dimensional. Under these conditions, the TIFD is an ideal tool for understanding and visualizing the process by which recursive simulation improves reliability and exhibits a threshold.

4 Quantum Pseudothresholds

We have seen that pseudothresholds exist even in a simple classical fault-tolerance scheme. In a quantum fault-tolerance scheme, the tools we have developed can now be applied to determine sequences of quantum pseudothresholds. In this section, we study thresholds for quantum fault-tolerance using the $[[7, 1, 3]]$ CSS code. We follow the circuit construction given in [14]. As in the classical example, TRIPs are again used to identify pseudothresholds for the given location types using particular settings, allowing us to determine the reliability achieved with each level of concatenation. In addition, we characterize the failure probability map using TIFDs.

4.1 *The $[[7, 1, 3]]$ code and its flow map*

The $[[7, 1, 3]]$ quantum code encodes a single qubit in 7 qubits with distance 3, meaning it corrects a general quantum error on a single qubit. The set of location types ℓ involved in the error correction routine is $\Omega = \{1, 2, w, 1m, p\}$:

- $\ell = 1$: one-qubit gate
- $\ell = 2$: two-qubit gate
- $\ell = w$: wait (memory) location
- $\ell = 1m$: one-qubit gate followed by a measurement [6], since the replacement rule for a measurement contains no error correction and since measurements in the networks for the 7-qubit code only appear after one-qubit gates
- $\ell = p$: ancilla preparation location, which we model as a one-qubit gate for simplicity [6]

We consider the depolarizing error model, where a location ℓ fails independently with probability γ_ℓ . In our probabilistic error model, we assume for a location failure γ_ℓ on a single qubit, a X, Y , or Z error occurs with probability $\gamma_\ell/3$. The distinction between X, Y , and Z errors is used in the approximation analysis.

As in the classical case, we define a replacement rule for each type of location. We use the same replacement rules as given in [6], where we replace each location by error correction followed by a fault-tolerant implementation of the location. For example, a one-qubit gate is replaced by error correction and a transversal one-qubit gate, as shown in Figure 9.

We use the same approach to derive the failure probability map as in the classical example, with the caveat that we do approximate counting of the ways in which two or more errors occur on the data qubits during the execution of the concatenated circuit. The composition of this map approximates the behavior of the concatenated circuit. This means that threshold results derived from this map are also approximate. The map does not account for incoming errors since when failure probabilities are below threshold, the probability of incoming errors should typically be small, and thus should not greatly affect the probability of two or more errors on the data qubits. The details of the failure probability map are given in Section IV B of [6].

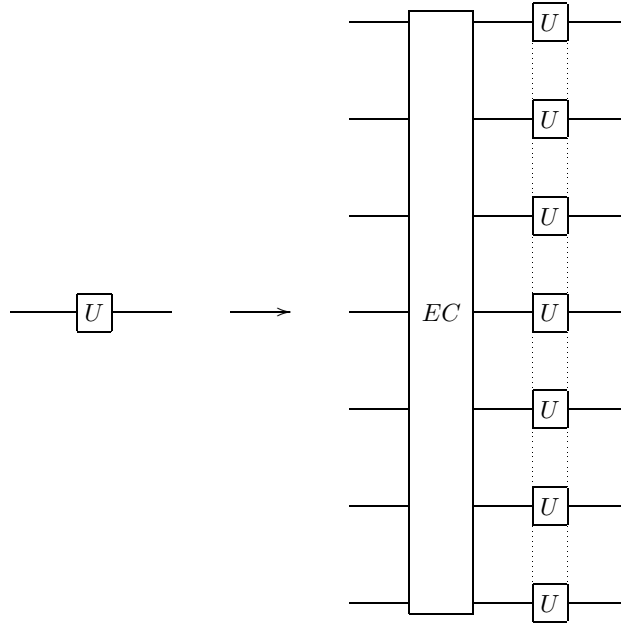

Fig. 9. Replacement rule for a one-qubit gate U . The replacement includes error correction (EC) followed by a fault-tolerant implementation of the one-qubit gate U , indicated by a dashed box.

4.2 TRIPs for the $[[7, 1, 3]]$ code

To determine pseudothresholds, we plot the reliability of each component at each level of concatenation using the flow maps. Figures 10–12 show TRIPs for wait, one-qubit, and two-qubit locations for the Steane setting $g(\gamma) = (\gamma, \gamma, \dots, \gamma, \gamma/10)$, where the last component is the wait location failure probability.

These results in this section are obtained using a flow map, but they are verified using a Monte-Carlo simulation for one level of code concatenation. The Monte-Carlo simulation method randomly generates faults within the fault-tolerant circuit representing the original location according to the failure probabilities γ_ℓ . These faults create errors that propagate to the output of the circuit. A particular set of faults may or may not create too many errors at the circuit's output. By running on the order of one million simulations, we can estimate the failure probability of the original location. The particular Monte-Carlo simulation includes the ancilla preparation networks but does not model input errors so as to agree with the assumptions under which the flow map is derived.

Figure 10 shows the TRIP for a wait location at levels $L = 0, 1, 2, 3, \infty$. Since the flow map is a multi-parameter map, the crossing points no longer cross the line $L = 0$ at the same point and thus pseudothresholds appear at each level. As L increases, the level- L pseudothreshold approaches an asymptotic threshold that depends on the location and setting. Note that the region between the $L = 1$ curve and the $L = 0$ line is quite small for these initial conditions, smaller than the region considered to be below the asymptotic threshold. This is similar to the behavior of the classical wait location. The behavior is largely due to the Steane setting – the level-1 simulation of the wait location includes other location types that have been set to fail with probability $10 \times \gamma_w^0$. However, as the level of concatenation of the wait location increases, the trade-offs between the failure probabilities of the location types begins to stabilize causing the level-4 pseudothreshold, for example, to be much larger and closer to the asymptotic threshold. The level-1 pseudothreshold as calculated from the flow map is 2.2×10^{-5} and the corresponding value from Monte-Carlo simulation is approximately

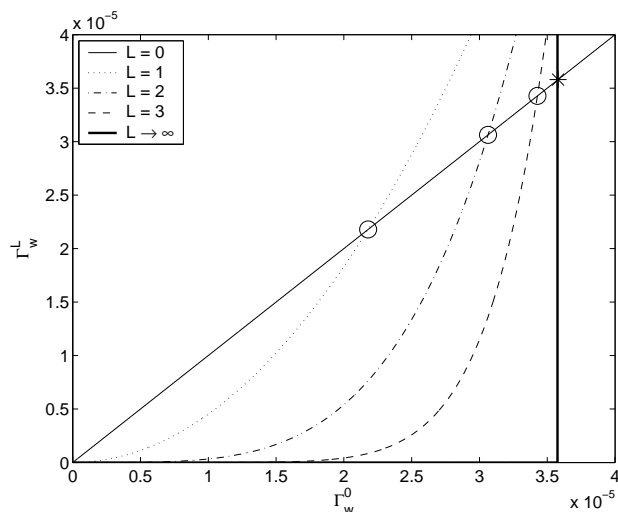

Fig. 10. TRIP for a wait location for $L = 0, 1, 2, 3, \infty$ for the initial setting $\gamma_w^0 = 1/10(\gamma_i^0)$, where i indicates all location types except for a wait location. Circles indicate pseudothresholds and an asterisk marks the threshold for this gate and setting. The pseudothresholds occur at probabilities 2.2×10^{-5} , 3.0×10^{-5} , and 3.4×10^{-5} . The wait threshold for this setting is 3.6×10^{-5} . This corresponds to $\gamma = 3.6 \times 10^{-4}$ in the Steane setting.

2.4×10^{-5} .

Figure 11 shows the TRIP for the one-qubit location type for levels $L = 0, 1, 2, 3, \infty$. The level-1 pseudothreshold is about 4.6 times greater than the asymptotic one-qubit gate threshold since the replacement $R(1)$ includes many wait locations, whose initial setting is one-tenth of the initial one-qubit gate failure probability. The Monte-Carlo simulation gives a level-1 pseudothreshold of approximately 1.3×10^{-3} versus an estimate of 1.4×10^{-3} from the flow map.

Similarly, for a two-qubit gate location, the level-1 pseudothreshold is a factor of 2 larger than the asymptotic two-qubit gate threshold (Figure 12). Note that the level-1 two-qubit gate pseudothreshold is about half the size of the level-1 one-qubit gate pseudothreshold. This is because error correction is required on two logical qubits and thus there are twice the number of locations in a one-qubit gate replacement. The level-1 pseudothreshold here is about 7.3×10^{-4} versus a Monte-Carlo estimate of about 6.4×10^{-4} .

From the threshold reliability information plots (TRIPs), it is apparent that multi-parameter maps and higher levels of concatenation are required to determine a threshold result. Across location types, the largest level-1 pseudothreshold is approximately 40 times larger than the smallest asymptotic gate threshold. The smallest asymptotic gate threshold is the memory threshold, so it is appropriate to scale this gate threshold by 10 to eliminate artifacts from the setting. The pseudothreshold-threshold factor then becomes 4.6 for this example.

4.3 TIFDs for the $[[7, 1, 3]]$ code

We use the TIFD to characterize the flow of the maps based on the semi-analytical methods of [6]. By using a TIFD instead of the TRIP, the flow of the failure probabilities as well as pseudothresholds can be visualized. In the quantum case, however, the TIFD is a 4-dimensional flow that is challenging to visualize. Instead, we take 2-dimensional projections to determine the flow.

Figures 13–14 show TIFDs involving location types $l = 1, 2, w$. Figure 13 shows the vector field $\Gamma^1(\vec{\gamma}) - \vec{\gamma}$ projected onto the $\gamma_1 - \gamma_w$ plane. Note that the flows are partitioned by

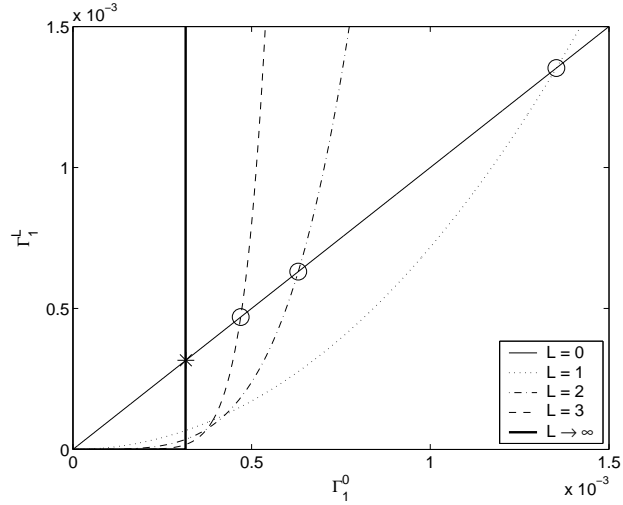

Fig. 11. TRIP for a one-qubit gate location for $L = 0, 1, 2, 3, \infty$ for the initial setting $\gamma_w^0 = 1/10(\gamma_i^0)$, where i indicates all location types except for a wait location. Circles indicate pseudothresholds and an asterisk marks the threshold for this gate and setting. The pseudothresholds occur at probabilities 1.4×10^{-3} , 6×10^{-4} , and 5×10^{-4} . The one-qubit gate threshold for this setting is 3×10^{-4} .

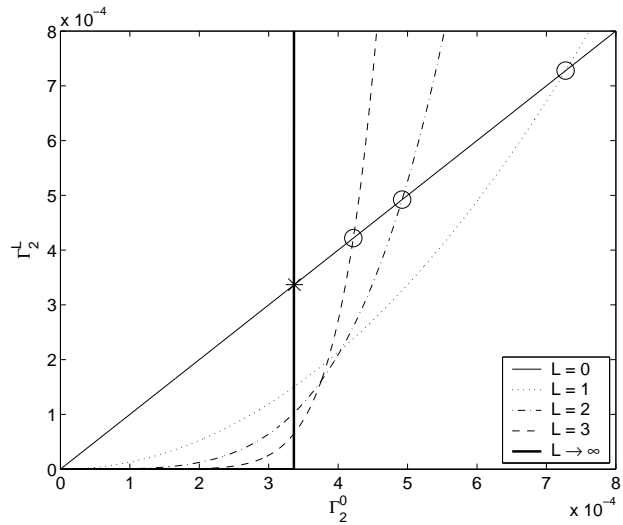

Fig. 12. TRIP for a two-qubit gate location for $L = 0, 1, 2, 3, \infty$ for the initial setting $\gamma_w^0 = 1/10(\gamma_i^0)$, where i indicates all location types except for a wait location. Circles indicate pseudothresholds and an asterisk marks the threshold for this gate and setting. The pseudothresholds occur at probabilities 7.3×10^{-4} , 4.9×10^{-4} , and 4.2×10^{-4} . The two-qubit gate threshold for this setting is 3.4×10^{-4} .

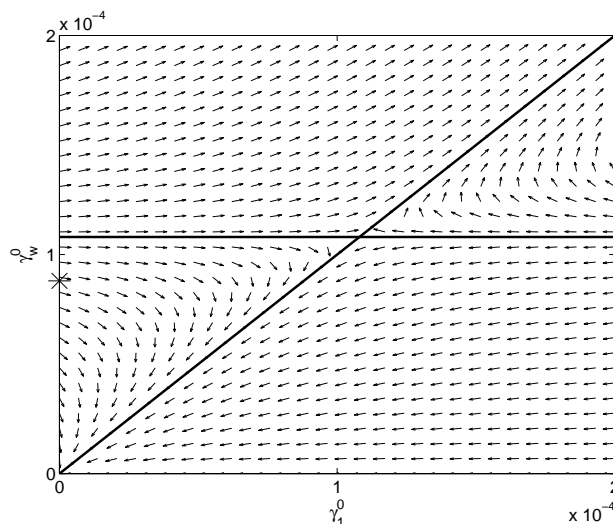

Fig. 13. TIFD projected onto the γ_1 - γ_w plane, where $\gamma_l^0 = 0$ for all l except γ_w^0 and γ_1^0 . The arrows represent the vector field flow $\Gamma^1(\vec{\gamma}) - \vec{\gamma}$. The thick lines illustrate the separatrices. The horizontal separatrix appears to have zero slope, but it intersects the γ_1^0 -axis at about 10^{-2} . The asterisk marks the wait gate asymptotic threshold for the setting in which $\gamma_w = \gamma$ and $\gamma_i = 0$ for all other location types.

separatrices shown by the thick black lines. The map is independent of concatenation level in our approximation, so this flow fully characterizes the behavior of the map. The γ_w threshold found by the horizontal separatrix appears around 1.1×10^{-4} . The asymptotic threshold for the map restricted to the γ_w -axis is indicated by an asterisk on the γ_w -axis. Note the separatrix indicates a wait location pseudothreshold.

Figure 14 is the TIFD projected onto the γ_1 - γ_2 plane. Again, the flows form a separatrix around $\gamma_2 = 2 \times \gamma_1$. This is because there are two error correction routines in a two-qubit gate replacement, compared to only one error correction routine in the replacement for a one-qubit gate. The γ_2 threshold appears along the other separatrix around 2.3×10^{-3} . The asymptotic threshold restricted to the γ_2 -axis, indicated by the asterisk, is a factor of 3.8 below the pseudothreshold.

In the classical setting, the TIFD indicated the asymptotic threshold, since the map was exact and only two-dimensional. However, it is evident from the TIFDs for the $[[7, 1, 3]]$ code that 2-dimensional projections of the flow are insufficient to determine the quantum fault-tolerance threshold set T . Since the threshold set is a multi-dimensional surface, the two-dimensional projection fails to indicate flow in the other dimensions. Although it appears the separatrices indicate a separation between points that flow to zero and those that flow to one, it cannot be used to determine the threshold, but it may be used to determine an upper bound on the threshold for this example.

5 Techniques for Determining the Asymptotic Threshold

In Section 4, low-dimensional projections of the flow using a TIFD were used to establish pseudothresholds. However, the TIFD could not be used to determine the asymptotic threshold γ_{th} . It may be possible, though, to bound γ_{th} for a particular map by restricting the map Γ to the axes. In this section, we describe a possible technique for upper bounding the fault-tolerance threshold γ_{th} .

Consider the following setting, the *axis setting*, where every initial failure probability is

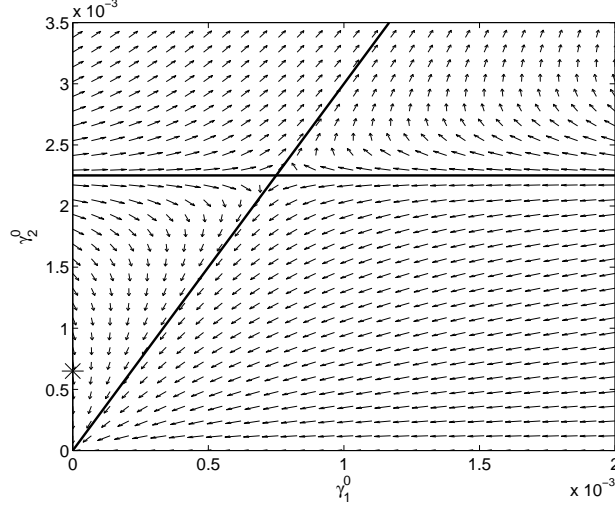

Fig. 14. TIFD projected onto the γ_1 - γ_2 plane, where $\gamma_l^0 = 0$ for all l except γ_1^0 and γ_2^0 . The arrows represent the vector field flow $\Gamma^1(\vec{\gamma}) - \vec{\gamma}$. The thick lines illustrate the separatrices. The horizontal separatrix appears to have zero slope, but it intersects the γ_1^0 -axis at about 10^{-2} . We do not show this intersection because the intersection with the γ_2^0 -axis at about 2.3×10^{-3} has a more significant role in determining the threshold. The asterisk marks the two-qubit gate threshold for the setting in which $\gamma_2 = \gamma$ and $\gamma_i = 0$ for all other location types.

0, except for the axis of interest, i.e., $g(\gamma) = (\gamma, 0, 0, \dots, 0)$, and γ is assigned to the location axis of interest. We conjecture that the level-1 pseudothreshold for this setting upper bounds γ_{th} .

Consider the plot shown in Figure 15 of the approximated γ_w pseudothresholds of the $[[7, 1, 3]]$ code for the axis setting. Note that the pseudothresholds for the wait location for the axis setting are strictly decreasing toward a threshold. We find similar behavior for the other location types as well. These pseudothresholds and the threshold found for the wait location are lower than the pseudothresholds and thresholds for the other location types in the axis setting. This suggests that the $L = 1$ wait location pseudothreshold for the axis setting, the smallest level-1 axis pseudothreshold, is an upper bound on γ_{th} .

This conclusion that pseudothresholds with the axis setting provide an upper bound on the fault-tolerance threshold is supported by numerical evaluation of the threshold set T in Figure 16. This figure shows four convex hulls: one pseudothreshold hull and three threshold hulls. The pseudothreshold hull is determined by the γ_1^1 , γ_2^1 , and γ_w^1 axis pseudothresholds, which are plotted as circles, while the threshold hulls were determined numerically from the flow map for a grid of parameters. The region of parameter space above the pseudothreshold hull is strictly above threshold for any value of γ_{1m} . The largest threshold hull corresponds to $\gamma_{1m}^0 = 0$ and all points beneath it are below threshold. Similarly, the other two threshold hulls correspond to $\gamma_{1m}^0 = 1.5 \times 10^{-3}$ and $\gamma_{1m}^0 = 3.5 \times 10^{-3}$.

Interestingly, as our choice of language indicates, T appears to be a convex set equal to the convex hull of the axes thresholds and the origin. The edge length of the largest cube in T is approximately $\gamma_{th} \approx 8.8 \times 10^{-5}$. Furthermore, T appears to be contained in the convex hull of the axes pseudothresholds and the origin. These pseudothresholds are $\gamma_1^1 \approx 4.4 \times 10^{-2}$, $\gamma_2^1 \approx 2.3 \times 10^{-3}$, and $\gamma_w^1 \approx 1.1 \times 10^{-4}$ for the corresponding axes settings. The γ_{1m}^1 pseudothreshold is comparable to γ_1^1 . The smallest level-1 pseudothreshold is $\gamma_w^1 \approx 1.1 \times 10^{-4}$, so this is an upper bound on γ_{th} for this example. Though the error

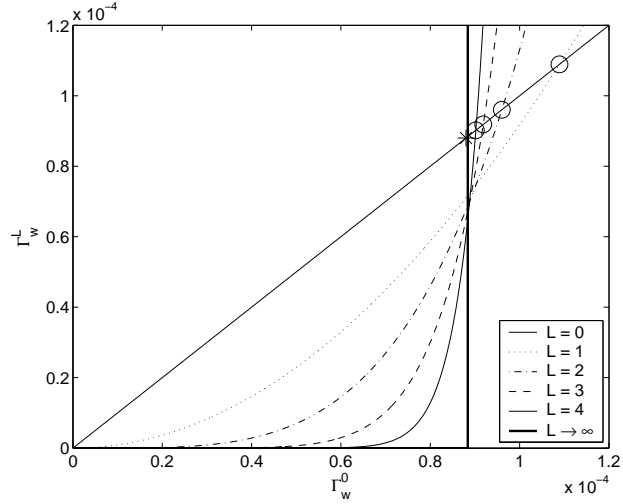

Fig. 15. TRIP for a wait location for $L = 0, 1, 2, 3, 4, \infty$ for the axis setting. The pseudothresholds are 1.1×10^{-4} , 9.6×10^{-5} , 9.2×10^{-5} , and 9.0×10^{-5} . The threshold for the wait location for this setting is 8.8×10^{-5} .

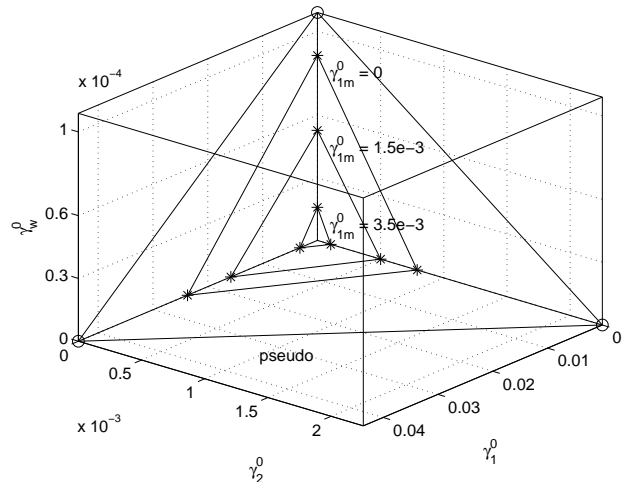

Fig. 16. The set T for the $[[7, 1, 3]]$ code together with a slice of the convex hull of the level-1 axis pseudothresholds. The level-1 axis pseudothresholds are plotted with open circles and connected with lines to illustrate their convex hull. The other three hulls are schematic representations of the numerically computed boundary of the set T for varying values of γ_{1m}^0 . All points beneath a given hull are below threshold. The largest cube contained in T has edge length $\gamma_{th} \approx 8.8 \times 10^{-5}$. Note that this does not contradict the wait location threshold in Figure 10 because the other locations are 10 times less reliable in that calculation.

correction networks are slightly different, this upper bound does not contradict a rigorous lower bound of 2.73×10^{-5} for the same code [16].

To further confirm the results found using the semi-analytical map, we use a Monte-Carlo simulation to determine pseudothresholds for the $[[7,1,3]]$ code. We find the following pseudothresholds with the axis setting by fitting a quadratic to the numerical TRIPS: $\gamma_1^1 \approx 8.0 \times 10^{-2}$, $\gamma_2^1 \approx 1.7 \times 10^{-3}$, and $\gamma_w^1 \approx 1.5 \times 10^{-4}$. The γ_1^1 pseudothreshold differs by a factor of 1.81 from the γ_1^1 pseudothreshold found using the flow map. The γ_2^1 and γ_w^1 pseudothresholds found using the flow map differ by a factor of 0.73 and a factor of 1.36, respectively, from numerical calculations based on a Monte-Carlo simulation. These differences could be reduced by revisiting some of the approximations in the flow map derivation.

While we do not prove our conjecture, we offer two supporting observations. The first is an observation that follows from the fact that the flow map has a threshold. There are positive integers A and t such that $\Gamma_\ell^1(\vec{\gamma}) \leq A\gamma_{max}^{t+1}$ for all ℓ , where $\gamma_{max} \equiv \max \gamma_\ell$. These integers determine the well-known lower bound $A^{-1/(t+1)} \equiv \gamma_{th}^{min} \leq \gamma_{th}$ on the threshold.

The next observation is that if Γ causes all components of $\vec{\gamma}$ to increase or remain unchanged, then $\vec{\gamma}$ is above the established lower bound γ_{th}^{min} . More precisely, if $\Gamma_\ell^1(\vec{\gamma}) \geq \gamma_\ell$ for all ℓ , then $\gamma_\ell \geq \gamma_{th}^{min}$ for at least one ℓ . This is true because if $\gamma_\ell < \gamma_{th}^{min}$ for all ℓ , then $\gamma_{max} < \gamma_{th}^{min}$. In particular, $\Gamma_\ell^1((\gamma_{max}, \gamma_{max}, \dots, \gamma_{max})) \leq A\gamma_{max}^{t+1} < \gamma_{max}$.

A $\vec{\gamma}$ satisfying the second observation is not necessarily above threshold, but we conjecture that this second observation remains true when γ_{th}^{min} is replaced by γ_{th} for maps Γ describing failure probabilities under independent stochastic error models. We know this to be the case for one-dimensional maps. If the conjecture is true in general, then the level-1 pseudothreshold for the axis setting upper bounds γ_{th} for a particular map.

6 Conclusions and Future Work

Pseudothresholds are the failure probabilities below which recursive simulation improves the reliability of a particular component. Yet, pseudothresholds have been shown to be up to a factor of 4 greater than the asymptotic threshold for the Steane setting and more than a factor of 10 different for the axes settings. This behavior is a generic phenomenon in both classical and quantum fault-tolerance. The tools we have presented provide a way to visualize pseudothresholds and thresholds, and we conjecture that for a given setting, they may provide an upper bound on the fault-tolerance threshold for a particular map.

Pseudothreshold behavior also influences the accuracy of some quantum threshold estimates. If some of the reported threshold estimates are actually pseudothresholds, the examples we have given suggest that these estimates may be inaccurate by a factor of 4 or more. These observations apply, in particular, to some numerical threshold estimates. However, other factors such as the noise model and circuit construction more greatly influence the threshold value and by making a judicious choice of concatenation level and setting, the difference between estimates and an asymptotic threshold can be reduced.

Although a fault-tolerance threshold for infinite scalability cannot be determined by low-level pseudothresholds, pseudothresholds will become important design parameters in engineering a quantum computer. In practice, quantum computers may operate very close to threshold and require only a few levels of recursive simulation. If this is the case, then pseudothresholds can help determine design trade-offs and the required relative reliability of circuit components. In addition, the difference between pseudothresholds can be used to determine an appropriate level of concatenation that is within current physical capabilities.

It is important to note that pseudothresholds can also be used to determine the frequency of error correction required for certain location types. If, for example, a level-1 pseudothreshold for a wait location shows the failure probability worsens upon concatenation, then it may be beneficial to not error correct each wait location, or to only error correct a wait location at higher levels of concatenation. This scheme will still demonstrate a threshold; however the failure probability map will have to take into account the differences between the replacement rules for each type of location at different levels of concatenation. By optimizing the frequency of error correction at different levels of concatenation and for different location types, the fault-tolerance threshold can be improved.

This work can be extended in several directions. First, we have put forward a conjecture that pseudothresholds may lead to upper bounds on γ_{th} . If this conjecture is true, then it would be interesting to determine how the concatenated flow map formalism could be modified to give rigorous bounds. It would also be useful to determine how much a pseudothreshold can differ from the fault-tolerance threshold.

Second, the analyses presented here only account for Clifford-group gates. We did not analyze a Toffoli, $\pi/8$, or other nontrivial gate needed for computational universality. It is still possible to apply the methods in this paper to those gates, but the corresponding flow map component is more difficult to estimate well. To determine a quantum fault-tolerance threshold, it is necessary to evaluate a computationally universal basis. With a universal basis, how much does the fault-tolerance threshold and sequence of pseudothresholds change?

7 Acknowledgements

We would like to thank one of our referees for suggesting the relationship between pseudothresholds and the frequency of error-correction operations. Krysta Svore acknowledges support from an NPSC fellowship, and Andrew Cross was supported by an NDSEG fellowship.

References

1. P. W. Shor (1994), *Algorithms for quantum computation: discrete logarithms and factoring*, In the 35th Annual Symposium on Foundations of Computer Science, pp. 124–134.
2. L. K. Grover (1997), *Quantum mechanics helps in searching for a needle in a haystack*, Phys. Rev. Let., 79:325.
3. S. Hallgren (2002), *Polynomial-time quantum algorithms for Pell’s equation and the principal ideal problem*, In Proceedings of the Thirty-Fourth Annual ACM Symposium on Theory of Computing, pp. 653–658.
4. J. von Neumann (1956), *Probabilistic logics and the synthesis of reliable organisms from unreliable components*, In Automata Studies, pp. 328–378, Princeton University Press.
5. J. Preskill (2001), *Fault-tolerant quantum computation*, In H. Lo, S. Popescu, and T. Spiller, editors, Introduction to quantum computation and information, World Scientific Publishing Company.
6. K. Svore, B. Terhal, and D. DiVincenzo (2005), *Local fault-tolerant quantum computation*, Phys. Rev. A, 72:022317.
7. D. Aharonov and M. Ben-Or (1997), *Fault-tolerant quantum computation with constant error*, Proceedings of the 29th Annual ACM Symposium on the Theory of Computation, pp. 176–188.
8. E. Dennis, A. Kitaev, A. Landahl, and J. Preskill (2002), *Topological quantum memory*, J. Math. Phys 43, pp. 4452–4505.
9. D. Gottesman (1997), *Stabilizer codes and quantum error correction*, Doctoral dissertation, Caltech.
10. E. Knill, R. Laflamme, and W. Zurek (1998), *Resilient quantum computation: error models and thresholds*, Science 279(5349).
11. E. Knill (2005), *Quantum computing with realistically noisy devices*, Nature 434, pp. 39–44.
12. T. Ohno, G. Arakawa, I. Ichinose, and T. Matsui (2004), *Phase structure of the random-plaquette Z_2 gauge model: accuracy threshold for a toric quantum memory*, Nuc. Phys. B 697, pp. 462–480.
13. B. Reichardt (2004), *Improved ancilla preparation scheme increases fault-tolerant threshold*, quant-ph/0406025.
14. A. M. Steane (2003), *Overhead and noise threshold of fault-tolerant quantum error correction*, Phys. Rev. A 68(042322).
15. C. Zalka (1996), *Threshold estimate for fault tolerant quantum computing*, quant-ph/9612028.
16. P. Aliferis, D. Gottesman, and J. Preskill (2005), *Quantum accuracy threshold for concatenated distance-3 codes*, To appear in Quantum Information and Computation.